

POWER & DATA

DEKKO

ECA 2021  
List Price Guide



furnlite

Dekko Family of Brands

# WHO WE ARE:

ECA is a leading designer and manufacturer of power, data, and modular electrical solutions for the office furniture industry. Our family of power and data modules extends from high-end table troughs used in conference room applications to simple power data grommets used in training table, library and educational applications. In addition, we offer a complete line of modular electrical wiring systems which can be easily integrated into many panel and furniture designs. We provide 8 wire systems in a variety of configurations to fill all power requirements. Our DaisyLink™ 4 wire, 2 circuit system is compatible with many of our power and data grommets making connecting multiple units together quick and easy.

With over 42 years experience, ECA has led the way in developing products which provide solutions to ever changing market needs. Commitments to product development, customer service and support and the manufacturing of quality products are our top priorities.

In 2016, ECA was acquired by Dekko. This combination positions ECA and Dekko as the North American market leader of electrical solutions serving the office furniture industry and related markets.

We provide consultative services on electrical layouts and overall product configuration. From minor product modifications to custom finish colors, we can easily accommodate these requests to ensure you get the most attractive and cost effective solution for your project.

## **ECA's Mission:**

ECA provides innovative power and data solutions. We are committed to delivering the ultimate customer experience by building strong relationships focused on our customer's individual needs.

## **ECA's Vision:**

To bring passionate people together to work hard, have fun, and inspire each other.

# TABLE OF CONTENTS— A-Z

---

ECA—Who We Are.....	<u>2</u>
ECA Policies.....	<u>119</u>
ECA Quick Ship Program Information.....	<u>4</u>
Aircharge Wireless Surface Grommet.....	<u>5</u>
Ashrae 90.1 Title 24 Solutions.....	<u>6-7</u>
Chicago Over Current Protection Products.....	<u>8-20</u>
Concept.....	<u>21</u>
Cove Series: <i>Corded &amp; DaisyLink</i> .....	<u>22-43</u>
Corded—Power Only.....	<u>23</u>
Corded—Power with Convenience Outlets.....	<u>24</u>
Corded—Power with Data Capability.....	<u>25</u>
Corded—Power with USB Charging.....	<u>27</u>
Corded—Round Configurations.....	<u>28</u>
Corded—Screw Mount Options.....	<u>29</u>
Corded—25 Watt Series.....	<u>31</u>
Corded—60 Watt Series.....	<u>36</u>
DaisyLink—Power Infeed Options & Interconnecting Cables.....	<u>38</u>
DaisyLink—Quick Kits & Build Your Own.....	<u>39</u>
Retro Series—LG,RJ, Mini.....	<u>81</u>
Tamper Resistant Receptacles (TR)—Corded & DaisyLink.....	<u>43</u>
Drifter.....	<u>44</u>
Departure.....	<u>45</u>
Interact G2.....	<u>46</u>
Interact G2 UT.....	<u>47</u>
Interact IV G2.....	<u>48</u>
Intercept.....	<u>49</u>
Interface G2.....	<u>50</u>
Interface G2 UT.....	<u>51</u>
Interface II TT.....	<u>52</u>
Interface II UT.....	<u>54</u>
Isle G2.....	<u>58</u>
Marina Grommets.....	<u>60</u>
Marina HDMI.....	<u>61</u>
Marina Power Dock.....	<u>62</u>
Oasis.....	<u>63</u>
Oasis UT.....	<u>66</u>
Oasis-Mini.....	<u>67</u>
Oasis-Mini UT.....	<u>70</u>
Poppy Wireless.....	<u>71</u>
Power Island.....	<u>72</u>
Power Slip.....	<u>74</u>
Power Strips.....	<u>76</u>
Reef.....	<u>77</u>
Reef Mini.....	<u>78</u>
Retro Series: <i>Corded &amp; DaisyLink</i> .....	<u>79-84</u>
Cove LG & Cove RJ.....	<u>79</u>
Cove Mini.....	<u>81</u>
Villa LG.....	<u>82</u>
Villa LG Grommets.....	<u>84</u>

## TABLE OF CONTENTS— A-Z (CONT.)

Runabout.....	<u>85</u>
Sandbar.....	<u>86</u>
Sand Dollar.....	<u>88</u>
Seclusion G2 Series.....	<u>89-95</u>
2 Power Configurations.....	<u>89</u>
4 Power Configurations.....	<u>90</u>
6 Power Configurations.....	<u>91</u>
60 Watt Series.....	<u>92</u>
G2 Mounting Accessories.....	<u>93</u>
Hide It Kit.....	<u>94</u>
Hide It Grommets.....	<u>95</u>
Sto-Way Locker Solutions.....	<u>96</u>
Telecom Plates.....	<u>98</u>
Telecom Plate Brackets—I PLY.....	<u>99</u>
Top Notch 2.....	<u>100</u>
Villa Series: <i>Corded &amp; DaisyLink</i> .....	<u>101-116</u>
Corded—Villa & Villa II.....	<u>101</u>
Corded— Villa UM.....	<u>111</u>
DaisyLink—Villa Series.....	<u>102</u>
DaisyLink—Villa II Series.....	<u>106</u>
DaisyLink—Villa & Villa II.....	<u>110</u>
DaisyLink—Villa UM & HAT Kits.....	<u>112</u>
DaisyLink—Power Infeed Options & Interconnecting Cables.....	<u>38</u>
Grommets.....	<u>116</u>
Wire Managers.....	<u>117</u>

---

## ECA’s Quick Ship Program

ECA has developed a Quick Ship program which features many of our most popular products shippable within 24 hours or 5 business days. Products on this program are marked throughout the price book with an \*. If you have any questions on your lead time visit our website at [www.electri-cable.com](http://www.electri-cable.com) for a current listing or contact customer service at 1-800-521-3175

---

## ECA Pricing Update

Effective immediately, ECA by Dekko will be adding a 3% Commodity Surcharge to all new orders. Please contact customer service for additional details.

# AIRCHARGE™ WIRELESS SURFACE GROMMET

Break Free From Wires.

**Black:**



**Aluminum:**

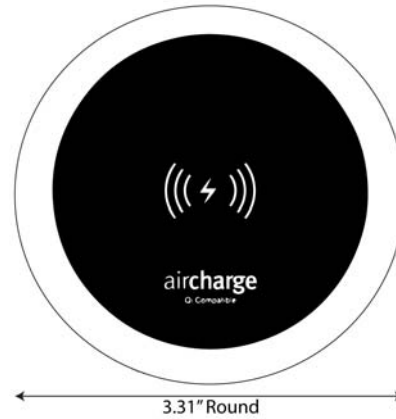

PART NUMBER	CONFIGURATION	FINISH	LIST PRICE
AIR-W-CHARGE-B	AirCharge wireless surface grommet. Includes USB cord with two pronged plug, steel mounting plate, screws, and cable clips.	Black	\$272.50
AIR-W-CHARGE-AL		Clear Aluminum	\$302.50
AIR-W-CHARGEWAL		White Aluminum	\$302.50

Please Note: AirCharge works with Qi technology, so a Qi compatible device or accessory is required.

## ACCESSORIES

PART NUMBER	CONFIGURATION	FINISH	LIST PRICE
AIR-MAC-B-MICRO	Wireless Charging Receiver for Micro-USB Devices	Black	\$50.00
AIR-MAC-B-LTNG	Wireless Charging Receiver with Lightning Cable	Black	\$70.00
AIR-RECEIVER-3	Orb Receiver includes Lightning, USB Type-C, and Micro-USB connectors.	Black	\$167.50

**PRODUCT INFORMATION:**

Unit Depth ..... .67"—.83"  
 Standard Table Thickness..... .71" - 1.97"  
 Table Cutout..... 80mm Round

# ASHRAE 90.1 AND TITLE 24 SOLUTIONS

## ENERGY MANAGEMENT SOLUTIONS

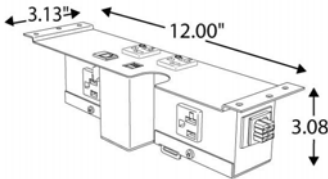
Villa II	PART NUMBER	CONFIGURATION	FINISH	LIST PRICE
	VIL2-4-TCC-UDB VIL2-4-TCC-UDS VIL2-4-TCC-UDGW	Energy Efficient Villa II with DaisyLink, (2) cir 1 Controlled Receptacles on top, (2) cir 2 non-controlled receptacles on bottom, (2) 2.1A USB charging ports, and (1) RJ45 cat6 data	Black Silver Gloss White	\$425.00
	VIL2-4-TCCUDKOB VIL2-4-TCCUDKOS VIL2-4TCCUDKOGW	Energy Efficient Villa II with DaisyLink, (2) cir 1 Controlled Receptacles on top, (2) cir 2 non-controlled receptacles on bottom, (2) 2.1A USB charging ports, and (1) data knockout	Black Silver Gloss White	\$367.50

See page 38 for Starter Cable and Interconnecting Cable Options. Villa Grommet sold separately, See page 119.

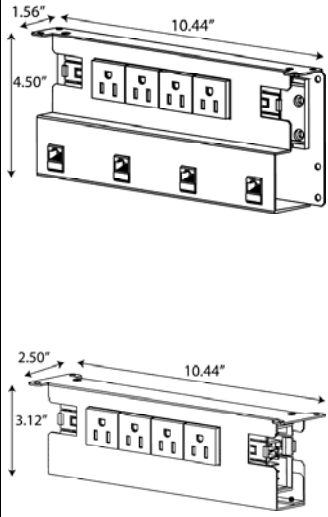
Sandbar	PART NUMBER	CONFIGURATION	FINISH	LIST PRICE
	84 SBSB1C2CIG4 84 SBS-S1C2C34	Single Sided Quad Power Bar with Circuits 1 & 2 Controlled, Circuit 3IG, Circuit 4 Receptacles. Knockouts for 4 RJ45 Cat 6 Data Jacks.	Black Silver	\$275.00
	84 SBS-B123C4C 84 SBS-S123C4C	Single Sided Quad Power Bar with Circuits 1 & 2, Circuits 3 & 4 Controlled Receptacles. Knockouts for 4 RJ45 Cat 6 Data Jacks.	Black Silver	\$275.00
	84SBSPB1C2CIG4 84 SBSPS1C2C34	Single Sided Quad Power Bar with Circuits 1 & 2 Controlled, Circuit 3IG, Circuit 4 Receptacles.	Black Silver	\$262.50
	84 SBSPB123C4C 84 SBSPS123C4C	Single Sided Quad Power Bar with Circuits 1 & 2, Circuits 3 & 4 Controlled Receptacles.	Black Silver	\$262.50
	84 SBDB1C2CIG4 84 SBD-S1C2C34	Double Sided Quad Power Bar with Circuits 1 & 2 Controlled, Circuit 3IG, Circuit 4 Receptacles. Knockouts for 8 RJ45 Cat 6 Data Jacks.	Black Silver	\$322.50
	84 SBD-B123C4C 84 SBD-S123C4C	Double Sided Quad Power Bar with Circuits 1 & 2, Circuits 3 & 4 Controlled Receptacles. Knockouts for 8 RJ45 Cat 6 Data Jacks.	Black Silver	\$322.50
	84SBDPB1C2CIG4 84 SBDPS1C2C34	Double Sided Quad Power Bar with Circuits 1 & 2 Controlled, Circuit 3IG, Circuit 4 Receptacles.	Black Silver	\$307.50
	84 SBDPB123C4C 84 SBDPS123C4C	Double Sided Quad Power Bar with Circuits 1 & 2, Circuits 3 & 4 Controlled Receptacles.	Black Silver	\$307.50

### PRODUCT INFORMATION:

Product Dimensions: See Specification and Ordering Information  
Minimum Table Thickness..... See Installation Sheets

Innovative Power + Data Solutions

10 Mountain View Drive • Shelton, CT 06484 • P:800.521.3175 • F:203.924.6687 • www.electri-cable.com

# AHSRAE 90.1 AND TITLE 24 SOLUTIONS (CONT.)

## ENERGY MANAGEMENT SOLUTIONS

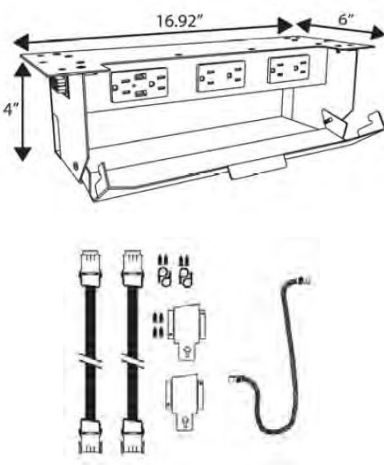
STEP: 1 Power Island Power Box	PART NUMBER	RECEPTACLES PER CIRCUIT (CONTROLLED CIRCUIT POWER)						LIST PRICE
		Circuit 1	Circuit 1 Controlled	Circuit 2	Circuit 2 Controlled	Circuit 3	Circuit 4	
	PI-84-21CC-UKOS		3	3				\$550.00
	PI-84-31CC-UKOS		3			3		
	PI-84-41CC-UKOS		3				3	
	PI-84-12CC-UKOS	3			3			
	PI-84-32CC-UKOS				3	3		
	PI-84-42CC-UKOS				3		3	

\*See Page 70 for Power Island DaisyLink Quick Kits Step 2 & 3

ETL Listed

### PRODUCT INFORMATION:



- Note DaisyLink® Quick Kits require Power Box, Cable Kit, and Power Infeed all ordered separately
- Product Dimensions: See Specification and Ordering Information
- Minimum Table Thickness.....See Installation Sheets

**Innovative Power + Data Solutions**

10 Mountain View Drive • Shelton, CT 06484 • P:800.521.3175 • F:203.924.6687 • [www.electri-cable.com](http://www.electri-cable.com)

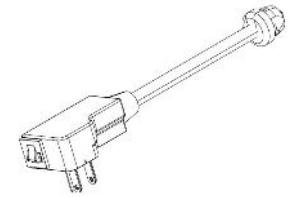
# CHICAGO OVER CURRENT PROTECTION



OVER CURRENT PROTECTION SERIES					
CONFIGURATIONS	PART NUMBER	FINISH	LIST PRICE 1-25 UNITS	LIST PRICE 26-250 UNITS	LIST PRICE 251+ UNITS
<b>Cove 60W</b> - (3) power receptacles, 60W USB A/C, 108" OCP Cord  	COV-3UC60SOC108	Silver Pearl	\$539.50	Call For Pricing	Call For Pricing
	COV-3UC60BOC108	Black	\$539.50	Call For Pricing	Call For Pricing
	COV-3UC60GWOC108	Gloss White	\$539.50	Call For Pricing	Call For Pricing
	COV-3UC60ALOC108	Brushed Aluminum	\$553.50	Call For Pricing	Call For Pricing
	COV-3UC60LBOC108	Lite Blue	\$544.50	Call For Pricing	Call For Pricing
	COV-3UC60LGOC108	Lite Green	\$544.50	Call For Pricing	Call For Pricing
	COV-3UC60POOC108	Pure Orange	\$544.50	Call For Pricing	Call For Pricing
	COV-3UC60SYOC108	Sulfur Yellow	\$544.50	Call For Pricing	Call For Pricing
	COV-3UC60SROC108	Signal Red	\$544.50	Call For Pricing	Call For Pricing
	COV-3UC60TXOC108	Tuxedo	\$544.50	Call For Pricing	Call For Pricing
<b>Cove 60W</b> - (2) power receptacles, 60W USB A/C, 108" OCP Cord  	COV-2UC60SOC108	Silver Pearl	\$487.00	Call For Pricing	Call For Pricing
	COV-2UC60BOC108	Black	\$487.00	Call For Pricing	Call For Pricing
	COV-2UC60GWOC108	Gloss White	\$487.00	Call For Pricing	Call For Pricing
	COV-2UC60ALOC108	Brushed Aluminum	\$501.00	Call For Pricing	Call For Pricing
	COV-2UC60LBOC108	Lite Blue	\$492.00	Call For Pricing	Call For Pricing
	COV-2UC60LGOC108	Lite Green	\$492.00	Call For Pricing	Call For Pricing
	COV-2UC60POOC108	Pure Orange	\$492.00	Call For Pricing	Call For Pricing
	COV-2UC60SYOC108	Sulfur Yellow	\$492.00	Call For Pricing	Call For Pricing
	COV-2UC60SROC108	Signal Red	\$492.00	Call For Pricing	Call For Pricing
	COV-2UC60TXOC108	Tuxedo	\$492.00	Call For Pricing	Call For Pricing



ETL Listed

Innovative Power + Data Solutions

10 Mountain View Drive • Shelton, CT 06484 • P:800.521.3175 • F:203.924.6687 • www.electri-cable.com



# CHICAGO OVER CURRENT PROTECTION (CONT.)

OVER CURRENT PROTECTION SERIES					
CONFIGURATIONS	PART NUMBER	FINISH	LIST PRICE 1-25 UNITS	LIST PRICE 26-250 UNITS	LIST PRICE 251+ UNITS
<b>Cove 60W</b> - (1) power receptacle, 60W USB A/C, 108" OCP Cord  	COV-1UC60SOC108	Silver Pearl	\$474.50	Call For Pricing	Call For Pricing
	COV-1UC60BOC108	Black	\$474.50	Call For Pricing	Call For Pricing
	COV1UC60GWOC108	Gloss White	\$474.50	Call For Pricing	Call For Pricing
	COV-1UC60ALOC108	Brushed Aluminum	\$488.50	Call For Pricing	Call For Pricing
	COV-1UC60LBOC108	Lite Blue	\$479.50	Call For Pricing	Call For Pricing
	COV-1UC60LGO C108	Lite Green	\$479.50	Call For Pricing	Call For Pricing
	COV-1UC60POOC108	Pure Orange	\$479.50	Call For Pricing	Call For Pricing
	COV-1UC60SYOC108	Sulfur Yellow	\$479.50	Call For Pricing	Call For Pricing
	COV-1UC60SROC108	Signal Red	\$479.50	Call For Pricing	Call For Pricing
	COV-1UC60TXOC108	Tuxedo	\$479.50	Call For Pricing	Call For Pricing
<b>Cove Mini-</b> (2) power receptacles, 108" cord  	COV-SM-2-SOC108	Silver Pearl	\$217.00	Call For Pricing	Call For Pricing
	COV-SM-2-BOC108	Black	\$217.00	Call For Pricing	Call For Pricing
	COV-SM-2GWOC108	Gloss White	\$217.00	Call For Pricing	Call For Pricing
	COV-SM-2ALOC108	Brushed Aluminum	\$284.50	Call For Pricing	Call For Pricing
<b>Cove Mini</b> - (1) power receptacle, (2) USB A, 108" cord  	COV-SM-1USOC108	Silver Pearl	\$257.50	Call For Pricing	Call For Pricing
	COV-SM-1UBOC108	Black	\$257.50	Call For Pricing	Call For Pricing
	COV-SM1UGWOC108	Gloss White	\$257.50	Call For Pricing	Call For Pricing
	COV-SM1UALOC108	Brushed Aluminum	\$338.50	Call For Pricing	Call For Pricing

ETL Listed

Innovative Power + Data Solutions

10 Mountain View Drive • Shelton, CT 06484 • P:800.521.3175 • F:203.924.6687 • www.electri-cable.com

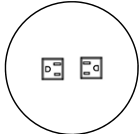
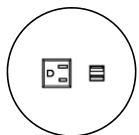
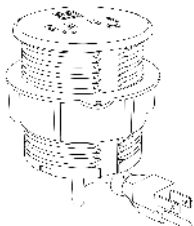

# CHICAGO OVER CURRENT PROTECTION (CONT.)

OVER CURRENT PROTECTION SERIES					
CONFIGURATIONS	PART NUMBER	FINISH	LIST PRICE 1-25 UNITS	LIST PRICE 26-250 UNITS	LIST PRICE 251+ UNITS
<b>Cove Mini Round</b> - (2) power receptacles, 108" cord, round 	COV-SMR-2SOC108	Silver Pearl	\$217.00	Call For Pricing	Call For Pricing
	COV-SMR-2BOC108	Black	\$217.00	Call For Pricing	Call For Pricing
	COV-SMR-2GWOC108	Gloss White	\$217.00	Call For Pricing	Call For Pricing
<b>Cove Mini Round</b> - (1) power receptacle, (2) USB A, 108" cord, round 	COV-SMR-1USOC108	Silver Pearl	\$254.50	Call For Pricing	Call For Pricing
	COV-SMR-1UBOC108	Black	\$254.50	Call For Pricing	Call For Pricing
	COV-SMR-1UGWOC108	Gloss White	\$254.50	Call For Pricing	Call For Pricing
<b>Sand Dollar</b> - 3", (2) power receptacles, (2) USB A, 72" OCP Cord 	SAN-3-2U-B-OC72	Black	\$94.00	Call For Pricing	Call For Pricing
	SAN-3-2U-W-OC72	White	\$94.00	Call For Pricing	Call For Pricing
	SAN-3-2U-GYOC72	Grey	\$94.00	Call For Pricing	Call For Pricing
	SAN-3-2U-LBOC72	Lite Blue	\$94.00	Call For Pricing	Call For Pricing
	SAN-3-2U-LGOC72	Lite Green	\$94.00	Call For Pricing	Call For Pricing
	SAN-3-2U-POOC72	Pure Orange	\$94.00	Call For Pricing	Call For Pricing
	SAN-3-2U-SYOC72	Sulfur Yellow	\$94.00	Call For Pricing	Call For Pricing
	SAN-3-2U-SROC72	Signal Red	\$94.00	Call For Pricing	Call For Pricing

ETL Listed

# CHICAGO OVER CURRENT PROTECTION (CONT.)

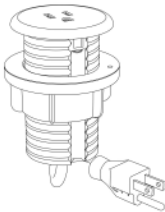
OVER CURRENT PROTECTION SERIES

CONFIGURATIONS	PART NUMBER	FINISH	LIST PRICE 1-25 UNITS	LIST PRICE 26-250 UNITS	LIST PRICE 251+ UNITS
<b>Sand Dollar</b> - 2", (1) power receptacle, 72" OCP Cord  	SAN-2-1-B-OC72	Black	\$43.00	Call For Pricing	Call For Pricing
	SAN-2-1-W-OC72	White	\$43.00	Call For Pricing	Call For Pricing
	SAN-2-1-GY-OC72	Grey	\$43.00	Call For Pricing	Call For Pricing
	SAN-2-1-LB-OC72	Lite Blue	\$43.00	Call For Pricing	Call For Pricing
	SAN-2-1-LG-OC72	Lite Green	\$43.00	Call For Pricing	Call For Pricing
	SAN-2-1-PO-OC72	Pure Orange	\$43.00	Call For Pricing	Call For Pricing
	SAN-2-1-SY-OC72	Sulfur Yellow	\$43.00	Call For Pricing	Call For Pricing
	SAN-2-1-SR-OC72	Signal Red	\$43.00	Call For Pricing	Call For Pricing
<b>Secusion 60W</b> - (2) power receptacles, 60W USB A/C, 72" OCP cord  	SEC-2UC60-SOC72	Silver Pearl	\$422.50	Call For Pricing	Call For Pricing
	SEC-2UC60-BOC72	Black	\$422.50	Call For Pricing	Call For Pricing
	SEC-2UC60-GBOC72	Gloss Black	\$422.50	Call For Pricing	Call For Pricing
	SEC-2UC60-GWOC72	Gloss White	\$422.50	Call For Pricing	Call For Pricing
	SEC-2UC60-LBOC72	Lite Blue	\$427.50	Call For Pricing	Call For Pricing
	SEC-2UC60-LGOC72	Lite Green	\$427.50	Call For Pricing	Call For Pricing
	SEC-2UC60-POOC72	Pure Orange	\$427.50	Call For Pricing	Call For Pricing
	SEC-2UC60-SYOC72	Sulfur Yellow	\$427.50	Call For Pricing	Call For Pricing
	SEC-2UC60-SROC72	Signal Red	\$427.50	Call For Pricing	Call For Pricing
	SEC-2UC60-TXOC72	Tuxedo	\$427.50	Call For Pricing	Call For Pricing

ETL Listed

# CHICAGO OVER CURRENT PROTECTION (CONT.)

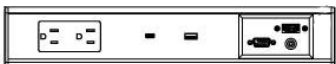
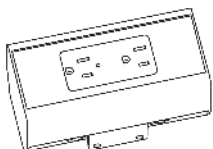
OVER CURRENT PROTECTION SERIES					
CONFIGURATIONS	PART NUMBER	FINISH	LIST PRICE 1-25 UNITS	LIST PRICE 26-250 UNITS	LIST PRICE 251+ UNITS
<b>Secusion 60W</b> - (2) power receptacles, 60W USB A/C, (1) TKO, 72" OCP cord  	SEC-2UC60DSOC72	Silver Pearl	\$422.50	Call For Pricing	Call For Pricing
	SEC-2UC60DBOC72	Black	\$422.50	Call For Pricing	Call For Pricing
	SEC2UC60DGBOC72	Gloss Black	\$422.50	Call For Pricing	Call For Pricing
	SEC2UC60DGWOC72	Gloss White	\$422.50	Call For Pricing	Call For Pricing
	SEC2UC60DLBOC72	Lite Blue	\$427.50	Call For Pricing	Call For Pricing
	SEC2UC60DLGOC72	Lite Green	\$427.50	Call For Pricing	Call For Pricing
	SEC2UC60DPOOC72	Pure Orange	\$427.50	Call For Pricing	Call For Pricing
	SEC2UC60DSYOC72	Sulfur Yellow	\$427.50	Call For Pricing	Call For Pricing
	SEC2UC60DSROC72	Signal Red	\$427.50	Call For Pricing	Call For Pricing
	SEC2UC60DTXOC72	Tuxedo	\$427.50	Call For Pricing	Call For Pricing
<b>Secusion G2</b> - (2) power receptacles, 72" OCP cord  	SEC-2-S-OC72	Silver Pearl	\$217.00	Call For Pricing	Call For Pricing
	SEC-2-B-OC72	Black	\$217.00	Call For Pricing	Call For Pricing
	SEC-2-GB-OC72	Gloss Black	\$217.00	Call For Pricing	Call For Pricing
	SEC-2-GW-OC72	Gloss White	\$217.00	Call For Pricing	Call For Pricing
	SEC-2-LB-OC72	Lite Blue	\$222.00	Call For Pricing	Call For Pricing
	SEC-2-LG-OC72	Lite Green	\$222.00	Call For Pricing	Call For Pricing
	SEC-2-PO-OC72	Pure Orange	\$222.00	Call For Pricing	Call For Pricing
	SEC-2-SY-OC72	Sulfur Yellow	\$222.00	Call For Pricing	Call For Pricing
	SEC-2-SR-OC72	Signal Red	\$222.00	Call For Pricing	Call For Pricing
	SEC-2-TX-OC72	Tuxedo	\$222.00	Call For Pricing	Call For Pricing

ETL Listed

Innovative Power + Data Solutions

10 Mountain View Drive • Shelton, CT 06484 • P:800.521.3175 • F:203.924.6687 • www.electri-cable.com

# CHICAGO OVER CURRENT PROTECTION (CONT.)

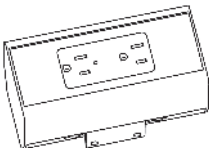
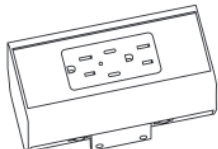
OVER CURRENT PROTECTION SERIES					
CONFIGURATIONS	PART NUMBER	FINISH	LIST PRICE 1-25 UNITS	LIST PRICE 26-250 UNITS	LIST PRICE 251+ UNITS
<b>Seclusion G2</b> - (2) power receptacles, 108" OCP cord  	SEC-2-S-OC108	Silver Pearl	\$230.75	Call For Pricing	Call For Pricing
	SEC-2-B-OC108	Black	\$230.75	Call For Pricing	Call For Pricing
	SEC-2-GB-OC108	Gloss Black	\$230.75	Call For Pricing	Call For Pricing
	SEC-2-GW-OC108	Gloss White	\$230.75	Call For Pricing	Call For Pricing
	SEC-2-LB-OC108	Lite Blue	\$235.75	Call For Pricing	Call For Pricing
	SEC-2-LG-OC108	Lite Green	\$235.75	Call For Pricing	Call For Pricing
	SEC-2-PO-OC108	Pure Orange	\$235.75	Call For Pricing	Call For Pricing
	SEC-2-SY-OC108	Sulfur Yellow	\$235.75	Call For Pricing	Call For Pricing
	SEC-2-SR-OC108	Signal Red	\$235.75	Call For Pricing	Call For Pricing
	SEC-2-TX-OC108	Tuxedo	\$235.75	Call For Pricing	Call For Pricing
<b>Seclusion G2</b> - (2) power receptacles, (2) USB C, 72" OCP cord  	SEC-2U2C-S-OC72	Silver Pearl	\$347.00	Call For Pricing	Call For Pricing
	SEC-2U2C-B-OC72	Black	\$347.00	Call For Pricing	Call For Pricing
	SEC-2U2C-GB-OC72	Gloss Black	\$347.00	Call For Pricing	Call For Pricing
	SEC-2U2C-GWOC72	Gloss White	\$347.00	Call For Pricing	Call For Pricing
	SEC-2U2C-LBOC72	Lite Blue	\$352.00	Call For Pricing	Call For Pricing
	SEC-2U2C-LGOC72	Lite Green	\$352.00	Call For Pricing	Call For Pricing
	SEC-2U2C-POOC72	Pure Orange	\$352.00	Call For Pricing	Call For Pricing
	SEC-2U2C-SYOC72	Sulfur Yellow	\$352.00	Call For Pricing	Call For Pricing
	SEC-2U2C-SROC72	Signal Red	\$352.00	Call For Pricing	Call For Pricing
	SEC-2U2C-TXOC72	Tuxedo	\$352.00	Call For Pricing	Call For Pricing

ETL Listed

# CHICAGO OVER CURRENT PROTECTION (CONT.)

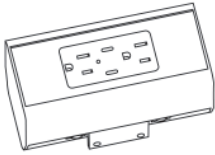
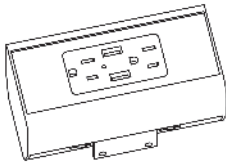
OVER CURRENT PROTECTION SERIES					
CONFIGURATIONS	PART NUMBER	FINISH	LIST PRICE 1-25 UNITS	LIST PRICE 26-250 UNITS	LIST PRICE 251+ UNITS
<b>Seclusion G2</b> - (2) power receptacles, (2) USB C, 108" OCP cord  	SEC-2U2C-SOC108	Silver Pearl	\$360.75	Call For Pricing	Call For Pricing
	SEC-2U2C-BOC108	Black	\$360.75	Call For Pricing	Call For Pricing
	SEC-2U2C-GBOC108	Gloss Black	\$360.75	Call For Pricing	Call For Pricing
	SEC-2U2CGWOC108	Gloss White	\$360.75	Call For Pricing	Call For Pricing
	SEC-2U2CLBOC108	Lite Blue	\$365.75	Call For Pricing	Call For Pricing
	SEC-2U2CLGOC108	Lite Green	\$365.75	Call For Pricing	Call For Pricing
	SEC-2U2CP0OC108	Pure Orange	\$365.75	Call For Pricing	Call For Pricing
	SEC-2U2CSYOC108	Sulfur Yellow	\$365.75	Call For Pricing	Call For Pricing
	SEC-2U2CSROC108	Signal Red	\$365.75	Call For Pricing	Call For Pricing
	SEC-2U2CTXOC108	Tuxedo	\$365.75	Call For Pricing	Call For Pricing
<b>Seclusion G2</b> - (2) power receptacles, (2) USB A, 72" OCP cord  	SEC-2U-S-OC72	Silver Pearl	\$282.00	Call For Pricing	Call For Pricing
	SEC-2U-B-OC72	Black	\$282.00	Call For Pricing	Call For Pricing
	SEC-2U-GB-OC72	Gloss Black	\$282.00	Call For Pricing	Call For Pricing
	SEC-2U-GW-OC72	Gloss White	\$282.00	Call For Pricing	Call For Pricing
	SEC-2U-LB-OC72	Lite Blue	\$287.00	Call For Pricing	Call For Pricing
	SEC-2U-LG-OC72	Lite Green	\$287.00	Call For Pricing	Call For Pricing
	SEC-2U-PO-OC72	Pure Orange	\$287.00	Call For Pricing	Call For Pricing
	SEC-2U-SY-OC72	Sulfur Yellow	\$287.00	Call For Pricing	Call For Pricing
	SEC-2U-SR-OC72	Signal Red	\$287.00	Call For Pricing	Call For Pricing
	SEC-2U-TX-OC72	Tuxedo	\$287.00	Call For Pricing	Call For Pricing

ETL Listed

# CHICAGO OVER CURRENT PROTECTION (CONT.)

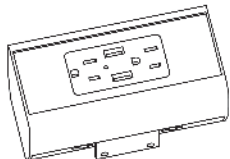
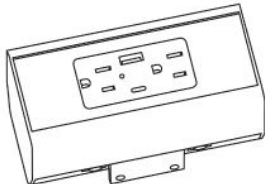
OVER CURRENT PROTECTION SERIES					
CONFIGURATIONS	PART NUMBER	FINISH	LIST PRICE 1-25 UNITS	LIST PRICE 26-250 UNITS	LIST PRICE 251+ UNITS
<b>Seclusion G2</b> - (2) power receptacles, (2) USB A, 108" OCP cord  	SEC-2U-S-OC108	Silver Pearl	\$295.75	Call For Pricing	Call For Pricing
	SEC-2U-B-OC108	Black	\$295.75	Call For Pricing	Call For Pricing
	SEC-2U-GB-OC108	Gloss Black	\$295.75	Call For Pricing	Call For Pricing
	SEC-2U-GW-OC108	Gloss White	\$295.75	Call For Pricing	Call For Pricing
	SEC-2U-LB-OC108	Lite Blue	\$300.75	Call For Pricing	Call For Pricing
	SEC-2U-LG-OC108	Lite Green	\$300.75	Call For Pricing	Call For Pricing
	SEC-2U-PO-OC108	Pure Orange	\$300.75	Call For Pricing	Call For Pricing
	SEC-2U-SY-OC108	Sulfur Yellow	\$300.75	Call For Pricing	Call For Pricing
	SEC-2U-SR-OC108	Signal Red	\$300.75	Call For Pricing	Call For Pricing
	SEC-2U-TX-OC108	Tuxedo	\$300.75	Call For Pricing	Call For Pricing
<b>Seclusion G2</b> - (2) power receptacles, USB A/C, 72" OCP cord  	SEC-2UAC-S-OC72	Silver Pearl	\$334.50	Call For Pricing	Call For Pricing
	SEC-2UAC-B-OC72	Black	\$334.50	Call For Pricing	Call For Pricing
	SEC-2UAC-GBOC72	Gloss Black	\$334.50	Call For Pricing	Call For Pricing
	SEC-2UAC-GWOC72	Gloss White	\$334.50	Call For Pricing	Call For Pricing
	SEC-2UAC-LBOC72	Lite Blue	\$339.50	Call For Pricing	Call For Pricing
	SEC-2UAC-LGOC72	Lite Green	\$339.50	Call For Pricing	Call For Pricing
	SEC-2UAC-POOC72	Pure Orange	\$339.50	Call For Pricing	Call For Pricing
	SEC-2UAC-SYOC72	Sulfur Yellow	\$339.50	Call For Pricing	Call For Pricing
	SEC-2UAC-SROC72	Signal Red	\$339.50	Call For Pricing	Call For Pricing
	SEC-2UAC-TXOC72	Tuxedo	\$339.50	Call For Pricing	Call For Pricing

ETL Listed

# CHICAGO OVER CURRENT PROTECTION (CONT.)

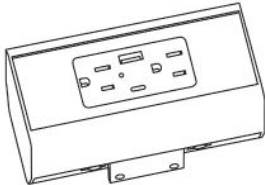
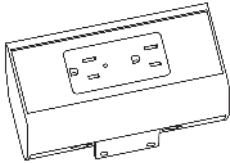
OVER CURRENT PROTECTION SERIES					
CONFIGURATIONS	PART NUMBER	FINISH	LIST PRICE 1-25 UNITS	LIST PRICE 26-250 UNITS	LIST PRICE 251+ UNITS
<p><b>Seclusion G2</b> - (2) power, USB A/C, 108" OCP cord</p> 	SEC-2UAC-SOC108	Silver Pearl	\$348.25	Call For Pricing	Call For Pricing
	SEC-2UAC-BOC108	Black	\$348.25	Call For Pricing	Call For Pricing
	SEC2UACGBOC108	Gloss Black	\$348.25	Call For Pricing	Call For Pricing
	SEC2UACGWOC108	Gloss White	\$348.25	Call For Pricing	Call For Pricing
	SEC2UACLBOC108	Lite Blue	\$353.25	Call For Pricing	Call For Pricing
	SEC2UACLGOC108	Lite Green	\$353.25	Call For Pricing	Call For Pricing
	SEC2UACPOOC108	Pure Orange	\$353.25	Call For Pricing	Call For Pricing
	SEC2UACSYOC108	Sulfur Yellow	\$353.25	Call For Pricing	Call For Pricing
	SEC2UACSROC108	Signal Red	\$353.25	Call For Pricing	Call For Pricing
	SEC2UACTXOC108	Tuxedo	\$353.25	Call For Pricing	Call For Pricing
<p><b>Seclusion G2</b> - (2) power receptacles, (1) TKO, 72" OCP cord</p>  <p>*Image shown is for representation only. Configuration imagery vary by model and/or series.</p>	SEC-2D-S-OC72	Silver Pearl	\$217.00	Call For Pricing	Call For Pricing
	SEC-2D-B-OC72	Black	\$217.00	Call For Pricing	Call For Pricing
	SEC-2DGBOC72	Gloss Black	\$217.00	Call For Pricing	Call For Pricing
	SEC-2DGWOC72	Gloss White	\$217.00	Call For Pricing	Call For Pricing
	SEC-2DLBOC72	Lite Blue	\$222.00	Call For Pricing	Call For Pricing
	SEC-2DLGOC72	Lite Green	\$222.00	Call For Pricing	Call For Pricing
	SEC-2DPOOC72	Pure Orange	\$222.00	Call For Pricing	Call For Pricing
	SEC-2DSYOC72	Sulfur Yellow	\$222.00	Call For Pricing	Call For Pricing
	SEC-2DSROC72	Signal Red	\$222.00	Call For Pricing	Call For Pricing
	SEC-2DTXOC72	Tuxedo	\$222.00	Call For Pricing	Call For Pricing

ETL Listed

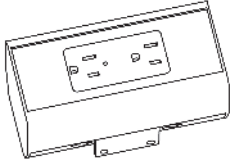
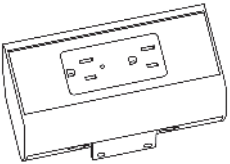

# CHICAGO OVER CURRENT PROTECTION (CONT.)

OVER CURRENT PROTECTION SERIES					
CONFIGURATIONS	PART NUMBER	FINISH	LIST PRICE 1-25 UNITS	LIST PRICE 26-250 UNITS	LIST PRICE 251+ UNITS
<p><b>Seclusion G2</b> - (2) power receptacles, (1) TKO, 108" OCP cord</p>  <p>*Image shown is for representation only. Configuration imagery vary by model and/or series.</p>	SEC-2D-S-OC108	Silver Pearl	\$230.75	Call For Pricing	Call For Pricing
	SEC-2D-B-OC108	Black	\$230.75	Call For Pricing	Call For Pricing
	SEC-2D-GB-OC108	Gloss Black	\$230.75	Call For Pricing	Call For Pricing
	SEC-2D-GW-OC108	Gloss White	\$230.75	Call For Pricing	Call For Pricing
	SEC-2D-LB-OC108	Lite Blue	\$235.75	Call For Pricing	Call For Pricing
	SEC-2D-LG-OC108	Lite Green	\$235.75	Call For Pricing	Call For Pricing
	SEC-2D-PO-OC108	Pure Orange	\$235.75	Call For Pricing	Call For Pricing
	SEC-2D-SY-OC108	Sulfur Yellow	\$235.75	Call For Pricing	Call For Pricing
	SEC-2D-SR-OC108	Signal Red	\$235.75	Call For Pricing	Call For Pricing
	SEC-2D-TX-OC108	Tuxedo	\$235.75	Call For Pricing	Call For Pricing
<p><b>Seclusion G2</b> - (2) power receptacles (2) USB A, (1) TKO, 72" OCP cord</p>  <p>*Image shown is for representation only. Configuration imagery vary by model and/or series.</p>	SEC-2UD-S-OC72	Silver Pearl	\$280.00	Call For Pricing	Call For Pricing
	SEC-2UD-B-OC72	Black	\$280.00	Call For Pricing	Call For Pricing
	SEC-2UD-GB-OC72	Gloss Black	\$280.00	Call For Pricing	Call For Pricing
	SEC-2UD-GW-OC72	Gloss White	\$280.00	Call For Pricing	Call For Pricing
	SEC-2UD-LB-OC72	Lite Blue	\$285.00	Call For Pricing	Call For Pricing
	SEC-2UD-LG-OC72	Lite Green	\$285.00	Call For Pricing	Call For Pricing
	SEC-2UD-PO-OC72	Pure Orange	\$285.00	Call For Pricing	Call For Pricing
	SEC-2UD-SY-OC72	Sulfur Yellow	\$285.00	Call For Pricing	Call For Pricing
	SEC-2UD-SR-OC72	Signal Red	\$285.00	Call For Pricing	Call For Pricing
	SEC-2UD-TX-OC72	Tuxedo	\$285.00	Call For Pricing	Call For Pricing

ETL Listed

# CHICAGO OVER CURRENT PROTECTION (CONT.)

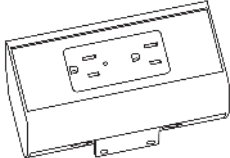
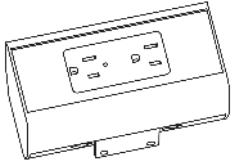
OVER CURRENT PROTECTION SERIES					
CONFIGURATIONS	PART NUMBER	FINISH	LIST PRICE 1-25 UNITS	LIST PRICE 26-250 UNITS	LIST PRICE 251+ UNITS
<p><b>Seclusion G2</b> - (2) power receptacles, USB A, (1) TKO, 108" OCP cord</p>  <p>*Image shown is for representation only. Configuration imagery vary by model and/or series.</p>	SEC-2UD-S-OC108	Silver Pearl	\$295.75	Call For Pricing	Call For Pricing
	SEC-2UD-B-OC108	Black	\$295.75	Call For Pricing	Call For Pricing
	SEC-2UD-GBOC108	Gloss Black	\$295.75	Call For Pricing	Call For Pricing
	SEC-2UD-GWOC108	Gloss White	\$295.75	Call For Pricing	Call For Pricing
	SEC-2UD-LBOC108	Lite Blue	\$300.75	Call For Pricing	Call For Pricing
	SEC-2UD-LGOC108	Lite Green	\$300.75	Call For Pricing	Call For Pricing
	SEC-2UD-POOC108	Pure Orange	\$300.75	Call For Pricing	Call For Pricing
	SEC-2UD-SYOC108	Sulfur Yellow	\$300.75	Call For Pricing	Call For Pricing
	SEC-2UD-SROC108	Signal Red	\$300.75	Call For Pricing	Call For Pricing
	SEC-2UD-TXOC108	Tuxedo	\$300.75	Call For Pricing	Call For Pricing
<p><b>Seclusion G2</b> - (2) power receptacles, USB A/C, (1) TKO, 72" OCP cord</p>  <p>*Image shown is for representation only. Configuration imagery vary by model and/or series.</p>	SEC-2UACD-SOC72	Silver Pearl	\$334.50	Call For Pricing	Call For Pricing
	SEC-2UACD-BOC72	Black	\$334.50	Call For Pricing	Call For Pricing
	SEC-2UACDGBOC72	Gloss Black	\$334.50	Call For Pricing	Call For Pricing
	SEC-2UACDGWOC72	Gloss White	\$334.50	Call For Pricing	Call For Pricing
	SEC-2UACDLBOC72	Lite Blue	\$339.50	Call For Pricing	Call For Pricing
	SEC-2UACDLGOC72	Lite Green	\$339.50	Call For Pricing	Call For Pricing
	SEC-2UACDPOOC72	Pure Orange	\$339.50	Call For Pricing	Call For Pricing
	SEC-2UACDSYOC72	Sulfur Yellow	\$339.50	Call For Pricing	Call For Pricing
	SEC-2UACDSROC72	Signal Red	\$339.50	Call For Pricing	Call For Pricing
	SEC-2UACDTXOC72	Tuxedo	\$339.50	Call For Pricing	Call For Pricing

ETL Listed

Innovative Power + Data Solutions

10 Mountain View Drive • Shelton, CT 06484 • P:800.521.3175 • F:203.924.6687 • www.electri-cable.com

# CHICAGO OVER CURRENT PROTECTION (CONT.)

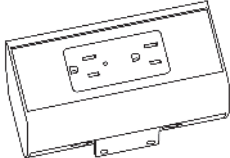
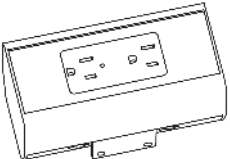
OVER CURRENT PROTECTION SERIES					
CONFIGURATIONS	PART NUMBER	FINISH	LIST PRICE 1-25 UNITS	LIST PRICE 26-250 UNITS	LIST PRICE 251+ UNITS
<p><b>Seclusion G2</b> - (2) power receptacles, USB A/C, (1) TKO, 108" OCP cord</p>  <p>*Image shown is for representation only. Configuration imagery vary by model and/or series.</p>	SEC-2UACDSOC108	Silver Pearl	\$348.25	Call For Pricing	Call For Pricing
	SEC-2UACDBOC108	Black	\$348.25	Call For Pricing	Call For Pricing
	SEC2UACDGBOC108	Gloss Black	\$348.25	Call For Pricing	Call For Pricing
	SEC2UACDGWOC108	Gloss White	\$348.25	Call For Pricing	Call For Pricing
	SEC2UACDLBOC108	Lite Blue	\$353.25	Call For Pricing	Call For Pricing
	SEC2UACDLGOC108	Lite Green	\$353.25	Call For Pricing	Call For Pricing
	SEC2UACDPOOC108	Pure Orange	\$353.25	Call For Pricing	Call For Pricing
	SEC2UACDSYOC108	Sulfur Yellow	\$353.25	Call For Pricing	Call For Pricing
	SEC2UACDSROC108	Signal Red	\$353.25	Call For Pricing	Call For Pricing
	SEC2UACDTXOC108	Tuxedo	\$353.25	Call For Pricing	Call For Pricing
<p><b>Seclusion G2</b> - (2) power receptacles, (2) USB C, (1) TKO, 72" OCP cord</p>  <p>*Image shown is for representation only. Configuration imagery vary by model and/or series.</p>	SEC-2U2CD-SOC72	Silver Pearl	\$347.00	Call For Pricing	Call For Pricing
	SEC-2U2CD-BOC72	Black	\$347.00	Call For Pricing	Call For Pricing
	SEC-2U2CDGBOC72	Gloss Black	\$347.00	Call For Pricing	Call For Pricing
	SEC-2U2CDGWOC72	Gloss White	\$347.00	Call For Pricing	Call For Pricing
	SEC-2U2CDLBOC72	Lite Blue	\$352.00	Call For Pricing	Call For Pricing
	SEC-2U2CDLGOC72	Lite Green	\$352.00	Call For Pricing	Call For Pricing
	SEC-2U2CDPOOC72	Pure Orange	\$352.00	Call For Pricing	Call For Pricing
	SEC-2U2CDSYOC72	Sulfur Yellow	\$352.00	Call For Pricing	Call For Pricing
	SEC-2U2CDSROC72	Signal Red	\$352.00	Call For Pricing	Call For Pricing
	SEC-2U2CDTXOC72	Tuxedo	\$352.00	Call For Pricing	Call For Pricing

ETL Listed

# CHICAGO OVER CURRENT PROTECTION (CONT.)

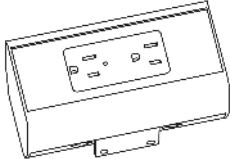
OVER CURRENT PROTECTION SERIES					
CONFIGURATIONS	PART NUMBER	FINISH	LIST PRICE 1-25 UNITS	LIST PRICE 26-250 UNITS	LIST PRICE 251+ UNITS
<p><b>Seclusion G2-</b> (2) power receptacles, (2) USB C, (1) TKO, 108" OCP cord</p>  <p>*Image shown is for representation only. Configuration imagery vary by model and/or series.</p>	SEC-2U2CDSOC108	Silver Pearl	\$360.75	Call For Pricing	Call For Pricing
	SEC-2U2CDBOC108	Black	\$360.75	Call For Pricing	Call For Pricing
	SEC2U2CDGBOC108	Gloss Black	\$360.75	Call For Pricing	Call For Pricing
	SEC2U2CDGWOC108	Gloss White	\$360.75	Call For Pricing	Call For Pricing
	SEC2U2CDLBOC108	Lite Blue	\$365.75	Call For Pricing	Call For Pricing
	SEC2U2CDLGOC108	Lite Green	\$365.75	Call For Pricing	Call For Pricing
	SEC2U2CDPOOC108	Pure Orange	\$365.75	Call For Pricing	Call For Pricing
	SEC2U2CDSYOC108	Sulfur Yellow	\$365.75	Call For Pricing	Call For Pricing
	SEC2U2CDSROC108	Signal Red	\$365.75	Call For Pricing	Call For Pricing
	SEC2U2CDTXOC108	Tuxedo	\$365.75	Call For Pricing	Call For Pricing

ETL Listed

# CONCEPT

Multi-dimensional Pop-up Power.

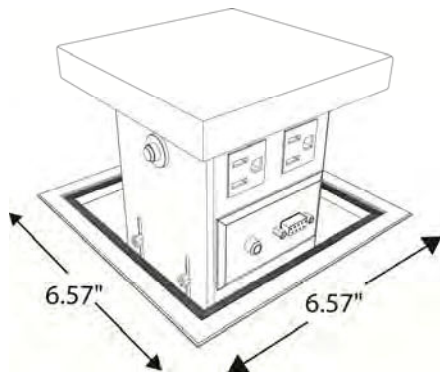

Concept Unit with Square Top and Trim Kit.

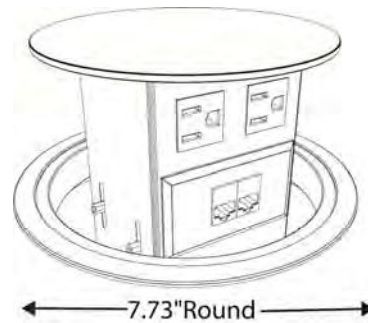

Concept Unit with Round Top and Trim Kit.

PART NUMBER	CONFIGURATION	FINISH	CORD	LIST PRICE
CON-S-B-SC-K CON-S-B-HW-K	Concept Unit, 4 Power, 2 Data Plate Knockouts, Manual Lift, will lift 4 lbs, Includes Black Square top and Trim Kit.	Black	72" Molded Plug 72" Hardwired	\$1,352.50 \$1,377.50
CON-S-SS-SC-K CON-S-SS-HW-K	Concept Unit, Manual Lift, will lift 4 lbs, Includes Brushed Stainless Steel Square top and Trim Kit.	Brushed Stainless Steel	72" Molded Plug 72" Hardwired	\$1,850.00 \$1,875.00

PART NUMBER	CONFIGURATION	FINISH	CORD	LIST PRICE
CON-R-B-SC-K CON-R-B-HW-K	Concept Unit, 4 Power, 2 Data Plate Knockouts, Manual Lift, will lift 4 lbs, Includes Black Round top and Trim Kit.	Black	72" Molded Plug 72" Hardwired	\$1,185.00 \$1,210.00
CON-R-SS-SC-K CON-R-SS-HW-K	Concept Unit, Manual Lift, will lift 4 lbs, Includes Brushed Stainless Steel Round top and Trim Kit.	Brushed Stainless Steel	72" Molded Plug 72" Hardwired	\$1,650.00 \$1,675.00

\*Telecom Plates Sold Separately, see page 100

CSA Certified

**TABLE REQUIREMENTS:**

Maximum Table Thickness.....1.5"

Table Cutout.....See Installation Instructions

## Configuration Grid

Number of Receptacles:	1	2	3	4	6
Power Only		✓	✓	✓	✓
USB	✓	✓	✓	✓	✓
Screw Mount	✓	✓	✓		
Convenience Outlet		✓	✓		
Data Capability			✓	✓	
USB & Data Capability		✓	✓	✓	✓

### Clamp Mount

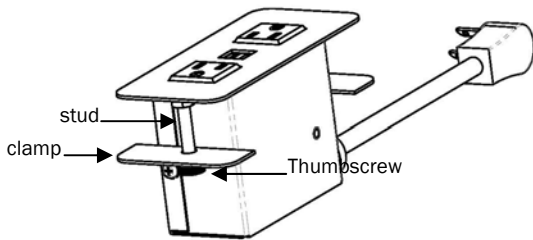

The Clamp mounting method requires no tools, and is best suited for installations where the back of the unit is easily accessible. The clamp mount works well for desks, benches, tables and case goods. The Cove is fastened to the furniture from the rear by tightening the thumbscrews.

### Screw Mount\*

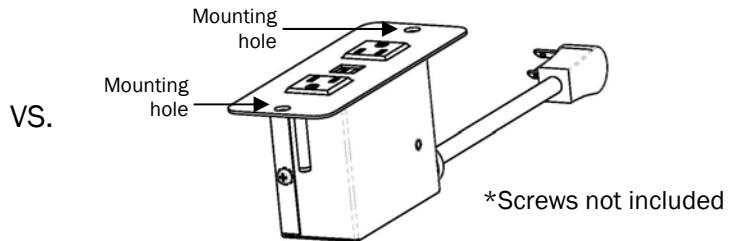

The screw mounting method is best suited to installations where the back of the unit has limited, or no access. Ideal for soft sided seating, lounge furniture and support columns. The screws are inserted from the front of the unit, through the face of the Cove, fastening the Cove to the furniture.

### Convenience Outlets\*\*

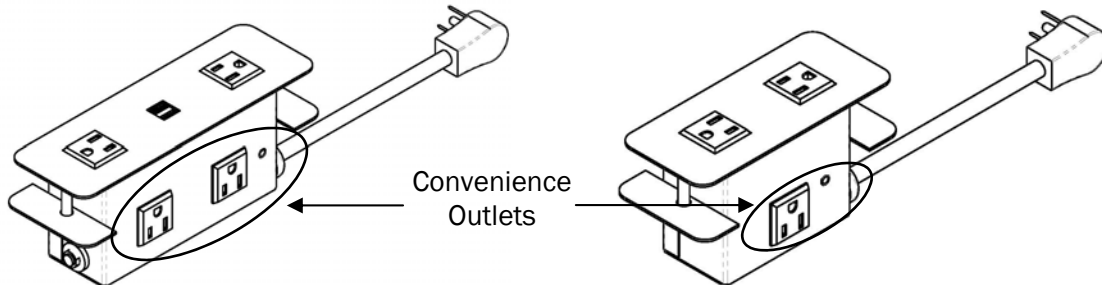



Convenience outlets are perfect for stationary accessories like lamps, computers, or monitors which do not need to be accessed often allowing more room to plug in temporary devices like laptops, tablets, and mobile phones above the work surface where they are more easily accessible.

\*\*Available on select models

# COVE™ SERIES – POWER ONLY

TABLETOP SOLUTIONS

2 POWER	PART NUMBER	FINISH	LIST PRICE
	COV-2-GW-108	Gloss White	\$235.00
	COV-2-S-108	Silver Pearl	\$235.00
	COV-2-B-108	Black	\$235.00
	COV-2-AL-108	Clear Brushed Aluminum	\$305.00

3 POWER	PART NUMBER	FINISH	LIST PRICE
	COV-3-GW-108	Gloss White	\$315.00
	COV-3-S-108	Silver Pearl	\$315.00
	COV-3-B-108	Black	\$315.00
	COV-3-AL-108	Clear Brushed Aluminum	\$382.50

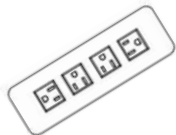
4 POWER	PART NUMBER	FINISH	LIST PRICE
	COV-4-GW-108	Gloss White	\$392.50
	COV-4-S-108	Silver Pearl	\$392.50
	COV-4-B-108	Black	\$392.50
	COV-4-AL-108	Clear Brushed Aluminum	\$462.50

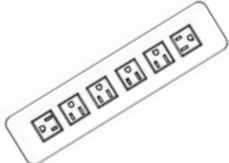
6 POWER	PART NUMBER	FINISH	LIST PRICE
	COV-6-GW-108	Gloss White	\$445.00
	COV-6-S-108	Silver Pearl	\$445.00
	COV-6-B-108	Black	\$445.00
	COV-6-AL-108	Clear Brushed Aluminum	\$515.00

PART NUMBER	DESCRIPTION	LIST PRICE
COV-1.5-BRKT	Optional Cove Bracket used with table thicknesses up to 1.50"	\$13.25

**PRODUCT INFORMATION:**

Product Dimensions: See Specification and Ordering Information

Standard Cord Length: 108"

Table Thickness..... .75"- 1.25"

Table Cutout.....See Installation Instructions

CORD LENGTH OPTION FEES	
COVE STANDARD CORD LENGTH = 108"	
36"	+ \$13.75
72"	+ \$13.75
144"	+ \$18.75
180"	+ \$25.00

**NOTE:** One Time \$295.00 Custom Cord Length Fee for all non-standard cord length requests

ETL Listed

Innovative Power + Data Solutions

10 Mountain View Drive • Shelton, CT 06484 • P:800.521.3175 • F:203.924.6687 • www.electri-cable.com



# COVE™ SERIES – POWER WITH CONVENIENCE OUTLETS

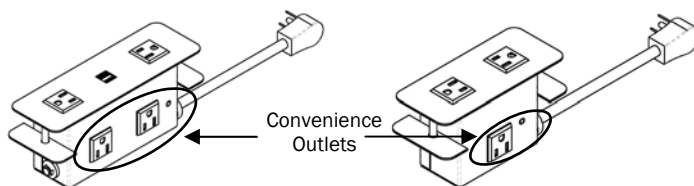

Convenience outlets are perfect for stationary accessories like lamps, computers, or monitors which do not need to be accessed often allowing more room to plug in temporary devices like laptops, tablets, and mobile phones above the work surface where they are more easily accessible.

2 POWER, 1 CONVENIENCE OUTLET	PART NUMBER	FINISH	LIST PRICE
	COV-21-GW-108	Gloss White	\$247.50
	COV-21-S-108	Silver Pearl	\$247.50
	COV-21-B-108	Black	\$247.50
	COV-21-AL-108	Clear Brushed Aluminum	\$317.50
2 POWER, 2 USB, 2 CONVENIENCE OUTLETS	PART NUMBER	FINISH	LIST PRICE
	COV-22U-GW108	Gloss White	\$445.00
	COV-22U-S-108	Silver Pearl	\$445.00
	COV-22U-B-108	Black	\$445.00
	COV-22U-AL108	Clear Brushed Aluminum	\$515.00
3 POWER, 2 USB, 1 CONVENIENCE OUTLETS	PART NUMBER	FINISH	LIST PRICE
	COV-31U-GW-108	Gloss White	\$445.00
	COV-31U-S-108	Silver Pearl	\$445.00
	COV-31U-B-108	Black	\$445.00
	COV-31U-AL-108	Clear Brushed Aluminum	\$515.00

PART NUMBER	DESCRIPTION	LIST PRICE
COV-1.5-BRKT	Optional Cove Bracket used with table thicknesses up to 1.50"	\$13.25

**PRODUCT INFORMATION:**

Product Dimensions: See Specification and Ordering Information  
 Standard Cord Length: 108"  
 Table Thickness..... .75"- 1.25"  
 Table Cutout.....See Installation Instructions

CORD LENGTH OPTION FEES	
COVE STANDARD CORD LENGTH = 108"	
36"	+ \$13.75
72"	+ \$13.75
144"	+ \$18.75
180"	+ \$25.00

**NOTE:** One Time \$295.00 Custom Cord Length Fee for all non-standard cord length requests

ETL Listed



# COVE™ SERIES – POWER WITH DATA CAPABILITY

Telecom Plates sold separately, see page 100

2 POWER, 2 USB, 1 PLATE CUTOUT	PART NUMBER	FINISH	LIST PRICE
	COV-2U-D-GW-108	Gloss White	\$315.00
	COV-2U-D-S-108	Silver Pearl	\$315.00
	COV-2U-D-B-108	Black	\$315.00
	COV-2U-D-AL-108	Clear Brushed Aluminum	\$382.50

3 POWER, 2 USB, 1 PLATE CUTOUT	PART NUMBER	FINISH	LIST PRICE
	COV-3U-D-GW-108	Gloss White	\$367.50
	COV-3U-D-S-108	Silver Pearl	\$367.50
	COV-3U-D-B-108	Black	\$367.50
	COV-3U-D-AL-108	Clear Brushed Aluminum	\$515.00

4 POWER, 2 USB, 1 PLATE CUTOUT	PART NUMBER	FINISH	LIST PRICE
	COV-4U-D-GW-108	Gloss White	\$445.00
	COV-4U-D-S-108	Silver Pearl	\$445.00
	COV-4U-D-B-108	Black	\$445.00
	COV-4U-D-AL-108	Clear Brushed Aluminum	\$515.00

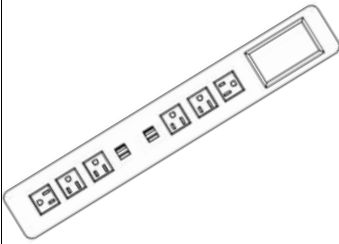
6 POWER, 4 USB, 1 PLATE CUTOUT	PART NUMBER	FINISH	LIST PRICE
	COV-6U-D-GW-108	Gloss White	\$577.50
	COV-6U-D-S-108	Silver Pearl	\$577.50
	COV-6U-D-B-108	Black	\$577.50
	COV-6U-D-AL-108	Clear Brushed Aluminum	\$645.00

PART NUMBER	DESCRIPTION	LIST PRICE
COV-1.5-BRKT	Optional Cove Bracket used with table thicknesses up to 1.50"	\$13.25

**PRODUCT INFORMATION:**

Product Dimensions: See Specification and Ordering Information  
 Standard Cord Length: 108"  
 Table Thickness..... .75"- 1.25"  
 Table Cutout.....See Installation Instructions

CORD LENGTH OPTION FEES	
COVE STANDARD CORD LENGTH = 108"	
36"	+ \$13.75
72"	+ \$13.75
144"	+ \$18.75
180"	+ \$25.00

**NOTE:** One Time \$295.00 Custom Cord Length Fee for all non-standard cord length

ETL Listed

# COVE™ SERIES – POWER WITH DATA CAPABILITY (CONT.)

Telecom Plates sold separately, see page 100

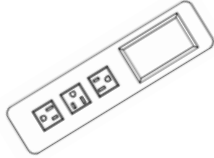
3 POWER, 1 PLATE CUTOUT	PART NUMBER	FINISH	LIST PRICE
	COV-3-D-GW-108	Gloss White	\$315.00
	COV-3-D-S-108	Silver Pearl	\$315.00
	COV-3-D-B-108	Black	\$315.00
	COV-3-D-AL-108	Clear Brushed Aluminum	\$382.50

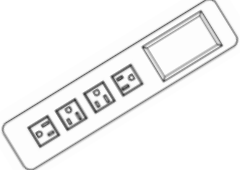
4 POWER, 1 PLATE CUTOUT	PART NUMBER	FINISH	LIST PRICE
	COV-4-D-GW-108	Gloss White	\$392.50
	COV-4-D-S-108	Silver Pearl	\$392.50
	COV-4-D-B-108	Black	\$392.50
	COV-4-D-AL-108	Clear Brushed Aluminum	\$462.50

# COVE™ SERIES- POWER WITH USB CHARGING

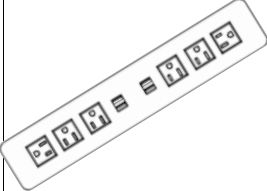
6 POWER, 4 USB	PART NUMBER	FINISH	LIST PRICE
	COV-6U-GW-108	Gloss White	\$577.50
	COV-6U-S-108	Silver Pearl	\$577.50
	COV-6U-B-108	Black	\$577.50
	COV-6U-AL-108	Clear Brushed Aluminum	\$645.00

Continued onto the next page...

PART NUMBER	DESCRIPTION	LIST PRICE
COV-1.5-BRKT	Optional Cove Bracket used with table thicknesses up to 1.50"	\$13.25

**PRODUCT INFORMATION:**

Product Dimensions: See Specification and Ordering Information

Standard Cord Length: 108"

Table Thickness..... .75"- 1.25"

Table Cutout.....See Installation Instructions

CORD LENGTH OPTION FEES	
COVE STANDARD CORD LENGTH = 108"	
<b>36"</b>	+ \$13.75
<b>72"</b>	+ \$13.75
<b>144"</b>	+ \$18.75
<b>180"</b>	+ \$25.00

**NOTE:** One Time \$295.00 Custom Cord Length Fee for all non-standard cord length

ETL Listed

# COVE™ SERIES- POWER WITH USB CHARGING (CONT.)

1 POWER, 2 USB	PART NUMBER	FINISH	LIST PRICE
	COV-1U-GW-108	Gloss White	\$300.00
	COV-1U-S-108	Silver Pearl	\$300.00
	COV-1U-B-108	Black	\$300.00
	COV-1U-AL-108	Clear Brushed Aluminum	\$370.00

2 POWER, 2 USB	PART NUMBER	FINISH	LIST PRICE
	COV-2U-GW-108	Gloss White	\$315.00
	COV-2U-S-108	Silver Pearl	\$315.00
	COV-2U-B-108	Black	\$315.00
	COV-2U-AL-108	Clear Brushed Aluminum	\$382.50

3 POWER, 2 USB	PART NUMBER	FINISH	LIST PRICE
	COV-3U-GW-108	Gloss White	\$367.50
	COV-3U-S-108	Silver Pearl	\$367.50
	COV-3U-B-108	Black	\$367.50
	COV-3U-AL-108	Clear Brushed Aluminum	\$515.00

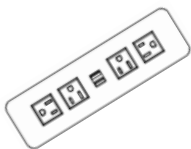
4 POWER, 2 USB	PART NUMBER	FINISH	LIST PRICE
	COV-4U-GW-108	Gloss White	\$445.00
	COV-4U-S-108	Silver Pearl	\$445.00
	COV-4U-B-108	Black	\$445.00
	COV-4U-AL-108	Clear Brushed Aluminum	\$515.00

PART NUMBER	DESCRIPTION	LIST PRICE
COV-1.5-BRKT	Optional Cove Bracket used with table thicknesses up to 1.50"	\$13.25

**PRODUCT INFORMATION:**

Product Dimensions: See Specification and Ordering Information

Standard Cord Length: 108"

Table Thickness..... .75" - 1.25"

Table Cutout.....See Installation Instructions

CORD LENGTH OPTION FEES	
COVE STANDARD CORD LENGTH = 108"	
36"	+ \$13.75
72"	+ \$13.75
144"	+ \$18.75
180"	+ \$25.00

**NOTE:** One Time \$295.00 Custom Cord Length Fee for all non-standard cord length requests

ETL Listed

# COVE™ SERIES— ROUND CONFIGURATIONS

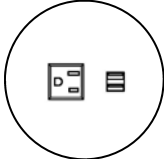
1 POWER, 2 USB	PART NUMBER	FINISH	LIST PRICE
	COV-R-1U-GW-108	Gloss White	\$327.50
	COV-R-1U-S-108	Silver Pearl	
	COV-R-1U-B-108	Black	

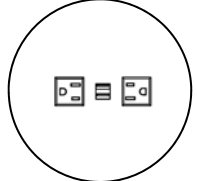
2 POWER, 2 USB	PART NUMBER	FINISH	LIST PRICE
	COV-R-2U-GW-108	Gloss White	\$315.00
	COV-R-2U-S-108	Silver Pearl	
	COV-R-2U-B-108	Black	

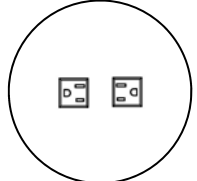
2 POWER ONLY	PART NUMBER	FINISH	LIST PRICE
	COV-R-2-GW-108	Gloss White	\$235.00
	COV-R-2-S-108	Silver Pearl	
	COV-R-2-B-108	Black	

PART NUMBER	DESCRIPTION	LIST PRICE
COV-1.5-BRKT	Optional Cove Bracket used with table thicknesses up to 1.50"	\$13.25

CORD LENGTH OPTION FEES	
COVE STANDARD CORD LENGTH = 108"	
36"	+ \$13.75
72"	+ \$13.75
144"	+ \$18.75
180"	+ \$25.00

**NOTE:** One Time \$295.00 Custom Cord Length Fee for all non-standard cord

ETL Listed

**PRODUCT INFORMATION:**

Product Dimensions: See Specification and Ordering Information

Standard Cord Length: 108"

Table Thickness..... .75"- 1.25"

Table Cutout.....See Installation Instructions

**Innovative Power + Data Solutions**

10 Mountain View Drive • Shelton, CT 06484 • P:800.521.3175 • F:203.924.6687 • [www.electri-cable.com](http://www.electri-cable.com)

# COVE™ SERIES – SCREW MOUNT OPTIONS

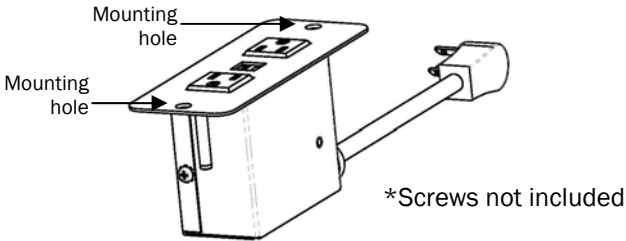

The screw mounting method is best suited to installations where the back of the unit has limited, or no access. Ideal for soft sided seating, lounge furniture and support columns. The screws are inserted from the front of the unit, through the face of the Cove, fastening the Cove to the furniture.

1 POWER, 2 USB, SCREW MOUNT	PART NUMBER	FINISH	LIST PRICE
	COV-1U-S-GW-108	Gloss White	\$300.00
	COV-1U-S-S-108	Silver Pearl	\$300.00
	COV-1U-S-B-108	Black	\$300.00
	COV-1U-S-AL-108	Clear Brushed Aluminum	\$370.00

2 POWER, SCREW MOUNT	PART NUMBER	FINISH	LIST PRICE
	COV-2-S-GW-108	Gloss White	\$235.00
	COV-2-S-S-108	Silver Pearl	\$235.00
	COV-2-S-B-108	Black	\$235.00
	COV-2-S-AL-108	Clear Brushed Aluminum	\$305.00

2 POWER, 2 USB, SCREW MOUNT	PART NUMBER	FINISH	LIST PRICE
	COV-2U-S-GW-108	Gloss White	\$315.00
	COV-2U-S-S-108	Silver Pearl	\$315.00
	COV-2U-S-B-108	Black	\$315.00
	COV-2U-S-AL-108	Clear Brushed Aluminum	\$382.50

CORD LENGTH OPTION FEES	
COVE STANDARD CORD LENGTH = 108"	
36"	+ \$13.75
72"	+ \$13.75
144"	+ \$18.75
180"	+ \$25.00

**NOTE:** One Time \$295.00 Custom Cord Length Fee for all non-standard cord length requests

ETL Listed

**PRODUCT INFORMATION:**

Product Dimensions: See Specification and Ordering Information

Standard Cord Length: 108"

Table Thickness..... .75"- 1.25"

Table Cutout.....See Installation Instructions

**Innovative Power + Data Solutions**

10 Mountain View Drive • Shelton, CT 06484 • P:800.521.3175 • F:203.924.6687 • [www.electri-cable.com](http://www.electri-cable.com)

# COVE™ SERIES – SCREW MOUNT OPTIONS (CONT.)

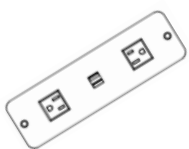
2 POWER, 2 USB, 2 CONVENIENCE OUTLETS, SCREW MOUNT	PART NUMBER	FINISH	LIST PRICE
	COV-22U-S-GW108	Gloss White	\$445.00
	COV-22U-S-S-108	Silver Pearl	\$445.00
	COV-22U-S-B-108	Black	\$445.00
	COV-22U-S-AL108	Clear Brushed Aluminum	\$515.00

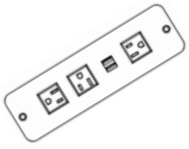
3 POWER, 2 USB, SCREW MOUNT	PART NUMBER	FINISH	LIST PRICE
	COV-3U-S-GW-108	Gloss White	\$367.50
	COV-3U-S-S-108	Silver Pearl	\$367.50
	COV-3U-S-B-108	Black	\$367.50
	COV-3U-S-AL-108	Clear Brushed Aluminum	\$515.00

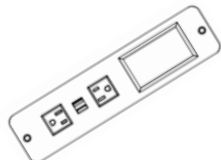
2 POWER, 2 USB, 1 PLATE CUTOUT, SCREW MOUNT	PART NUMBER	FINISH	LIST PRICE
	COV-2U-S-DGW108	Gloss White	\$315.00
	COV-2U-S-D-S108	Silver Pearl	\$315.00
	COV-2U-S-D-B108	Black	\$315.00
	COV-2U-S-DAL108	Clear Brushed Aluminum	\$382.50

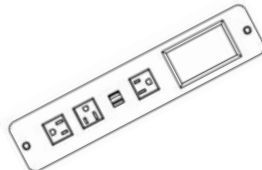
3 POWER, 2 USB, 1 PLATE CUTOUT, SCREW MOUNT	PART NUMBER	FINISH	LIST PRICE
	COV-3U-S-DGW108	Gloss White	\$367.50
	COV-3U-S-D-S-108	Silver Pearl	\$367.50
	COV-3U-S-D-B-108	Black	\$367.50
	COV-3U-S-D-AL-108	Clear Brushed Aluminum	\$515.00

\*Telecom Plates sold separately, see page 100

CORD LENGTH OPTION FEES	
COVE STANDARD CORD LENGTH = 108"	
36"	+ \$13.75
72"	+ \$13.75
144"	+ \$18.75
180"	+ \$25.00

**NOTE:** One Time \$295.00 Custom Cord Length Fee for all non-standard cord length requests

ETL Listed

**PRODUCT INFORMATION:**

Product Dimensions: See Specification and Ordering Information

Standard Cord Length: 108"

Table Thickness..... .75" - 1.25"

Table Cutout.....See Installation Instructions

**Innovative Power + Data Solutions**

10 Mountain View Drive • Shelton, CT 06484 • P:800.521.3175 • F:203.924.6687 • [www.electri-cable.com](http://www.electri-cable.com)

# COVE 25 WATT SERIES - CORDED

## CLAMP-MOUNT - POWER & USB/USB-C ONLY

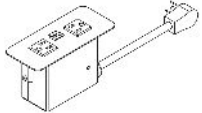
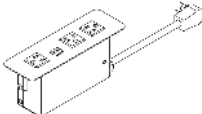
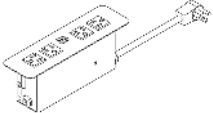
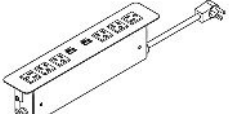
1 POWER, 1 USB-A, 1 USB-C, 108" CORD	PART NUMBER	FINISH	LIST PRICE
	COV-1UAC-S-108	Silver	\$337.50
	COV-1UAC-B-108	Black	\$337.50
	COV-1UAC-GW-108	Gloss White	\$337.50
	COV-1UAC-AL-108	Brushed Aluminum	\$407.50
2 POWER, 1 USB-A, 1 USB-C, 108" CORD	PART NUMBER	FINISH	LIST PRICE
	COV-2UAC-S-108	Silver	\$352.50
	COV-2UAC-B-108	Black	\$352.50
	COV-2UAC-GW-108	Gloss White	\$352.50
	COV-2UAC-AL-108	Brushed Aluminum	\$420.00
3 POWER, 1 USB-A, 1 USB-C, 108" CORD	PART NUMBER	FINISH	LIST PRICE
	COV-3UAC-S-108	Silver	\$405.00
	COV-3UAC-B-108	Black	\$405.00
	COV-3UAC-GW-108	Gloss White	\$405.00
	COV-3UAC-AL-108	Brushed Aluminum	\$475.00
4 POWER, 1 USB-A, 1 USB-C, 108" CORD	PART NUMBER	FINISH	LIST PRICE
	COV-4UAC-S-108	Silver	\$482.50
	COV-4UAC-B-108	Black	\$482.50
	COV-4UAC-GW-108	Gloss White	\$482.50
	COV-4UAC-AL-108	Brushed Aluminum	\$530.00
6 POWER, 2 USB-A, 2 USB-C, 108" CORD	PART NUMBER	FINISH	LIST PRICE
	COV-6UAC-S-108	Silver	\$615.00
	COV-6UAC-B-108	Black	\$615.00
	COV-6UAC-GW-108	Gloss White	\$615.00
	COV-6UAC-AL-108	Brushed Aluminum	\$682.50

CORD LENGTH OPTION FEES	
COVE STANDARD CORD LENGTH = 108"	
36"	+ \$5.50
72"	+ \$5.50
144"	+ \$7.50
180"	+ \$10.00

**NOTE:** One Time \$295.00 Custom Cord Length Fee for all non-standard cord length requests

**PRODUCT INFORMATION:**

Product Dimensions: See Specification and Ordering Information

Standard Cord Length: 108"

Table Thickness..... .75"- 1.25"

Table Cutout.....See Installation Instructions

ETL Listed

**Innovative Power + Data Solutions**

10 Mountain View Drive • Shelton, CT 06484 • P:800.521.3175 • F:203.924.6687 • [www.electri-cable.com](http://www.electri-cable.com)

# COVE 25 WATT SERIES - CORDED

## CLAMP-MOUNT - TELECOM PLATE KNOCKOUTS

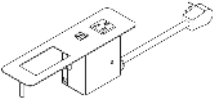
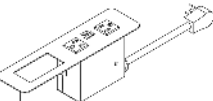
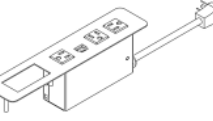
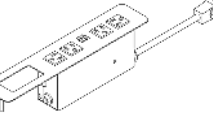
1 POWER,1 USB-A,1 USB-C, 1 TKO,108"CORD	PART NUMBER	FINISH	LIST PRICE
	COV-1UACD-S-108	Silver	\$337.50
	COV-1UACD-B-108	Black	\$337.50
	COV-1UACD-GW108	Gloss White	\$337.50
	COV-1UACD-AL108	Brushed Aluminum	\$407.50
2 POWER,1USB-A,1USB-C, 1 TKO,108"CORD	PART NUMBER	FINISH	LIST PRICE
	COV-2UACD-S-108	Silver	\$352.50
	COV-2UACD-B-108	Black	\$352.50
	COV-2UACD-GW108	Gloss White	\$352.50
	COV-2UACD-AL108	Brushed Aluminum	\$420.00
3 POWER,1USB-A,1USB-C, 1TKO,108"CORD	PART NUMBER	FINISH	LIST PRICE
	COV-3UACD-S-108	Silver	\$405.00
	COV-3UACD-B-108	Black	\$405.00
	COV-3UACD-GW108	Gloss White	\$405.00
	COV-3UACD-AL108	Brushed Aluminum	\$475.00
4 POWER,1USB-A,1USB-C, 1 TKO, 108"CORD	PART NUMBER	FINISH	LIST PRICE
	COV-4UACD-S-108	Silver	\$482.50
	COV-4UACD-B-108	Black	\$482.50
	COV-4UACD-GW108	Gloss White	\$482.50
	COV-4UACD-AL108	Brushed Aluminum	\$530.00

CORD LENGTH OPTION FEES	
COVE STANDARD CORD LENGTH = 108"	
36"	+ \$5.50
72"	+ \$5.50
144"	+ \$7.50
180"	+ \$10.00

**NOTE:** One Time \$295.00 Custom Cord Length Fee for all non-standard cord length requests

\*Telecom Plates sold separately, see page 100

**PRODUCT INFORMATION:**

Product Dimensions: See Specification and Ordering Information

Standard Cord Length: 108"

Table Thickness..... .75"- 1.25"

Table Cutout.....See Installation Instructions

ETL Listed

**Innovative Power + Data Solutions**

10 Mountain View Drive • Shelton, CT 06484 • P:800.521.3175 • F:203.924.6687 • www.electri-cable.com



# COVE 25 WATT SERIES - CORDED

## CLAMP-MOUNT - CONVENIENCE OUTLETS

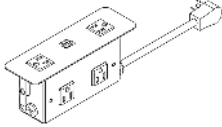
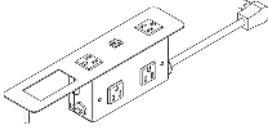
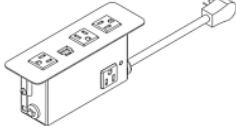
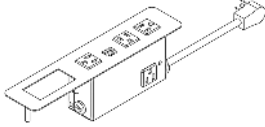
2 POWER, 1 USB-A, 1 USB-C, 2 CONVENIENCE OUTLETS, 108" CORD	PART NUMBER	FINISH	LIST PRICE
	COV-22UAC-S-108	Silver	\$482.50
	COV-22UAC-B-108	Black	\$482.50
	COV-22UAC-GW108	Gloss White	\$482.50
	COV-22UAC-AL108	Brushed Aluminum	\$530.00
2 POWER, 1 USB-A, 1 USB-C, 1 TKO, 2 CONVENIENCE OUTLETS 108" CORD	PART NUMBER	FINISH	LIST PRICE
	COV-22UACD-S108	Silver	\$482.50
	COV-22UACD-B108	Black	\$482.50
	COV-22UACD-GW108	Gloss White	\$482.50
	COV-22UACDAL108	Brushed Aluminum	\$530.00
3 POWER, 1 USB-A, 1 USB-C, 1 CONVENIENCE OUTLET, 108" CORD	PART NUMBER	FINISH	LIST PRICE
	COV-31UAC-S-108	Silver	\$482.50
	COV-31UAC-B-108	Black	\$482.50
	COV-31UAC-GW108	Gloss White	\$482.50
	COV-31UAC-AL108	Brushed Aluminum	\$530.00
3 POWER, 1 USB-A, 1 USB-C, 1 TKO, 1 CONVENIENCE OUTLET, 108" CORD	PART NUMBER	FINISH	LIST PRICE
	COV-31UACD-S108	Silver	\$482.50
	COV-31UACD-B108	Black	\$482.50
	COV-31UACD-GW108	Gloss White	\$482.50
	COV-31UACDAL108	Brushed Aluminum	\$530.00

CORD LENGTH OPTION FEES	
COVE STANDARD CORD LENGTH = 108"	
<b>36"</b>	+ \$5.50
<b>72"</b>	+ \$5.50
<b>144"</b>	+ \$7.50
<b>180"</b>	+ \$10.00

**NOTE:** One Time \$295.00 Custom Cord Length Fee for all non-standard cord length requests

\*Telecom Plates sold separately, see page 100

**PRODUCT INFORMATION:**

Product Dimensions: See Specification and Ordering Information  
 Standard Cord Length: 108"  
 Table Thickness..... .75"- 1.25"  
 Table Cutout.....See Installation Instructions

ETL Listed

**Innovative Power + Data Solutions**

10 Mountain View Drive • Shelton, CT 06484 • P:800.521.3175 • F:203.924.6687 • www.electri-cable.com

# COVE 25 WATT SERIES - CORDED

## SCREW-MOUNT - POWER & USB/USB-C ONLY

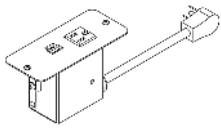
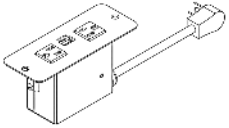
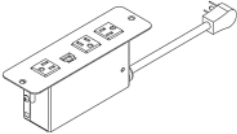
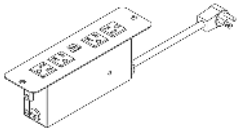
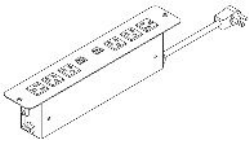
1 POWER, 1 USB-A, 1 USB-C, 108" CORD	PART NUMBER	FINISH	LIST PRICE
	COV-1UAC-S-S108	Silver	\$337.50
	COV-1UAC-S-B108	Black	\$337.50
	COV-1UAC-S-GW108	Gloss White	\$337.50
	COV-1UAC-S-SAL108	Brushed Aluminum	\$407.50
2 POWER, 1 USB-A, 1 USB-C, 108" CORD	PART NUMBER	FINISH	LIST PRICE
	COV-2UAC-S-S108	Silver	\$352.50
	COV-2UAC-S-B108	Black	\$352.50
	COV-2UAC-S-GW108	Gloss White	\$352.50
	COV-2UAC-S-SAL108	Brushed Aluminum	\$420.00
3 POWER, 1 USB-A, 1 USB-C, 108" CORD	PART NUMBER	FINISH	LIST PRICE
	COV-3UAC-S-S108	Silver	\$405.00
	COV-3UAC-S-B108	Black	\$405.00
	COV-3UAC-S-GW108	Gloss White	\$405.00
	COV-3UAC-S-SAL108	Brushed Aluminum	\$475.00
4 POWER, 1 USB-A, 1 USB-C, 108" CORD	PART NUMBER	FINISH	LIST PRICE
	COV-4UAC-S-S108	Silver	\$482.50
	COV-4UAC-S-B108	Black	\$482.50
	COV-4UAC-S-GW108	Gloss White	\$482.50
	COV-4UAC-S-SAL108	Brushed Aluminum	\$530.00
6 POWER, 2 USB-A, 2 USB-C, 108" CORD	PART NUMBER	FINISH	LIST PRICE
	COV-6UAC-S-S108	Silver	\$615.00
	COV-6UAC-S-B108	Black	\$615.00
	COV-6UAC-S-GW108	Gloss White	\$615.00
	COV-6UAC-S-SAL108	Brushed Aluminum	\$682.50

CORD LENGTH OPTION FEES	
<b>COVE STANDARD CORD LENGTH = 108"</b>	
<b>36"</b>	+ \$5.50
<b>72"</b>	+ \$5.50
<b>144"</b>	+ \$7.50
<b>180"</b>	+ \$10.00

**NOTE:** One Time \$295.00 Custom Cord Length Fee for all non-standard cord length requests

**PRODUCT INFORMATION:**

Product Dimensions: See Specification and Ordering Information

Standard Cord Length: 108"

Table Thickness..... .75"- 1.25"

Table Cutout.....See Installation Instructions

ETL Listed

**Innovative Power + Data Solutions**

10 Mountain View Drive • Shelton, CT 06484 • P:800.521.3175 • F:203.924.6687 • [www.electri-cable.com](http://www.electri-cable.com)

# COVE 25 WATT SERIES - CORDED

## SCREW-MOUNT - TELECOM PLATE KNOCKOUTS

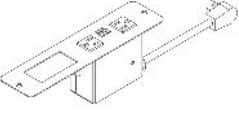
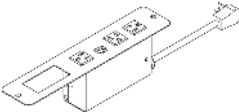
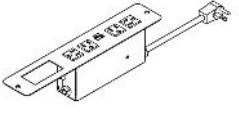
2 POWER, 1 USB-A, 1 USB-C, 1 TKO, 108" CORD	PART NUMBER	FINISH	LIST PRICE
	COV-2UACS-DS108	Silver	\$352.50
	COV-2UACS-DB108	Black	\$352.50
	COV-2UACSDGW108	Gloss White	\$352.50
	COV-2UACSDAL108	Brushed Aluminum	\$420.00
3 POWER, 1 USB-A, 1 USB-C, 1 TKO, 108" CORD	PART NUMBER	FINISH	LIST PRICE
	COV-3UACS-DS108	Silver	\$405.00
	COV-3UACS-DB108	Black	\$405.00
	COV-3UACSDGW108	Gloss White	\$405.00
	COV-3UACSDAL108	Brushed Aluminum	\$475.00
4 POWER, 1 USB-A, 1 USB-C, 1 TKO, 108" CORD	PART NUMBER	FINISH	LIST PRICE
	COV-4UACS-DS108	Silver	\$482.50
	COV-4UACS-DB108	Black	\$482.50
	COV-4UACSDGW108	Gloss White	\$482.50
	COV-4UACSDAL108	Brushed Aluminum	\$530.00

# COVE 25 WATT SERIES - CORDED

## SCREW-MOUNT - CONVENIENCE OUTLETS

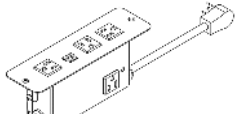
3 POWER, 1 USB-A, 1 USB-C, 1 CONVENIENCE OUTLET, 108" CORD	PART NUMBER	FINISH	LIST PRICE
	COV-31UACS-S108	Silver	\$482.50
	COV-31UACS-B108	Black	\$482.50
	COV-31UACSGW108	Gloss White	\$482.50
	COV-31UACsAL108	Brushed Aluminum	\$530.00

\*Telecom Plates sold separately, see page 100

**PRODUCT INFORMATION:**

Product Dimensions: See Specification and Ordering Information

Standard Cord Length: 108"

Table Thickness..... .75" - 1.25"

Table Cutout.....See Installation Instructions

CORD LENGTH OPTION FEES	
<b>COVE STANDARD CORD LENGTH = 108"</b>	
<b>36"</b>	+ \$5.50
<b>72"</b>	+ \$5.50
<b>144"</b>	+ \$7.50
<b>180"</b>	+ \$10.00



**NOTE:** One Time \$295.00 Custom Cord Length Fee for all non-standard cord length requests

ETL Listed

**Innovative Power + Data Solutions**

10 Mountain View Drive • Shelton, CT 06484 • P:800.521.3175 • F:203.924.6687 • [www.electri-cable.com](http://www.electri-cable.com)

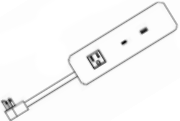
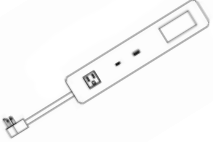
# COVE™ SERIES – 60 Watt

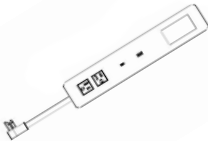
1 POWER, 60W USB A/C, 108" CORD	PART NUMBER	FINISH	LIST PRICE 1-25 UNITS	LIST PRICE 26-250 UNITS	LIST PRICE 251+ UNITS
	COV-1UC60-S-108	Silver	\$467.50	Call for Pricing	Call for Pricing
	COV-1UC60-B-108	Black	\$467.50		
	COV-1UC60-GW108	Gloss White	\$467.50		
	COV-1UC60-AL108	Brushed Aluminum	\$502.50		
1 POWER, 60W USB A/C, TKO, 108" CORD	PART NUMBER	FINISH	LIST PRICE 1-25 UNITS	LIST PRICE 26-250 UNITS	LIST PRICE 251+ UNITS
	COV-1UC60D-S108	Silver	\$467.50	Call for Pricing	Call for Pricing
	COV-1UC60D-B108	Black	\$467.50		
	COV-1UC60D-GW108	Gloss White	\$467.50		
	COV-1UC60DAL108	Brushed Aluminum	\$502.50		
2 POWER, 60W USB A/C, 108" CORD	PART NUMBER	FINISH	LIST PRICE 1-25 UNITS	LIST PRICE 26-250 UNITS	LIST PRICE 251+ UNITS
	COV-2UC60-S-108	Silver	\$480.00	Call for Pricing	Call for Pricing
	COV-2UC60-B-108	Black	\$480.00		
	COV-2UC60-GW108	Gloss White	\$480.00		
	COV-2UC60-AL108	Brushed Aluminum	\$515.00		
2 POWER, 60W USB A/C, TKO, 108" CORD	PART NUMBER	FINISH	LIST PRICE 1-25 UNITS	LIST PRICE 26-250 UNITS	LIST PRICE 251+ UNITS
	COV-2UC60D-S108	Silver	\$480.00	Call for Pricing	Call for Pricing
	COV-2UC60D-B108	Black	\$480.00		
	COV-2UC60D-GW108	Gloss White	\$480.00		
	COV-2UC60DAL108	Brushed Aluminum	\$515.00		

\*Telecom Plates sold separately, see page 100

ADDITIONAL FINISH OPTIONS	CORD LENGTH OPTION FEES	
<b>LB</b> - Light Blue <b>LG</b> - Light Green <b>PO</b> - Pure Orange <b>SR</b> - Signal Red <b>SY</b> - Sulfur Yellow <b>TX</b> - Tuxedo <small>*For information, contact customer service.</small>	COVE STANDARD CORD LENGTH = 108"	
	<b>36"</b>	+ \$5.50
	<b>72"</b>	+ \$5.50
	<b>144"</b>	+ \$7.50
	<b>180"</b>	+ \$10.00

ETL Listed

**NOTE:** One Time \$295.00 Custom Cord Length Fee for all non-standard cord length requests

**PRODUCT INFORMATION:**

Product Dimensions: See Specification and Ordering Information  
 Standard Cord Length: 108"  
 Table Thickness..... .75"- 1.25"  
 Table Cutout.....See Installation Instructions

Innovative Power + Data Solutions

10 Mountain View Drive • Shelton, CT 06484 • P:800.521.3175 • F:203.924.6687 • www.electri-cable.com

# COVE™ SERIES – 60 Watt (Cont.)

3 POWER, 60W USB A/C, 108" CORD	PART NUMBER	FINISH	LIST PRICE 1-25 UNITS	LIST PRICE 26-250 UNITS	LIST PRICE 251+ UNITS
	COV-3UC60-S-108	Silver	\$532.50	Call for Pricing	Call for Pricing
	COV-3UC60-B-108	Black	\$532.50		
	COV-3UC60-GW108	Gloss White	\$532.50		
	COV-3UC60-AL108	Brushed Aluminum	\$567.50		
3 POWER, 60W USB A/C, TKO, 108" CORD	PART NUMBER	FINISH	LIST PRICE 1-25 UNITS	LIST PRICE 26-250 UNITS	LIST PRICE 251+ UNITS
	COV-3UC60D-S108	Silver	\$532.50	Call for Pricing	Call for Pricing
	COV-3UC60D-B108	Black	\$532.50		
	COV-3UC60D GW108	Gloss White	\$532.50		
	COV-3UC60DAL108	Brushed Aluminum	\$567.50		
4 POWER, 60W USB A/C, 108" CORD	PART NUMBER	FINISH	LIST PRICE 1-25 UNITS	LIST PRICE 26-250 UNITS	LIST PRICE 251+ UNITS
	COV-4UC60-S-108	Silver	\$610.00	Call for Pricing	Call for Pricing
	COV-4UC60-B-108	Black	\$610.00		
	COV-4UC60-GW108	Gloss White	\$610.00		
	COV-4UC60-AL108	Brushed Aluminum	\$645.00		
4 POWER, 60W USB A/C, TKO, 108" CORD	PART NUMBER	FINISH	LIST PRICE 1-25 UNITS	LIST PRICE 26-250 UNITS	LIST PRICE 251+ UNITS
	COV-4UC60D-S108	Silver	\$610.00	Call for Pricing	Call for Pricing
	COV-4UC60D-B108	Black	\$610.00		
	COV-4UC60D GW108	Gloss White	\$610.00		
	COV-4UC60DAL108	Brushed Aluminum	\$645.00		

\*Telecom Plates sold separately, see page 100

ADDITIONAL FINISH OPTIONS	CORD LENGTH OPTION FEES	
<b>LB</b> - Light Blue <b>LG</b> - Light Green <b>PO</b> - Pure Orange <b>SR</b> - Signal Red <b>SY</b> - Sulfur Yellow <b>TX</b> - Tuxedo <small>*For information, contact customer service.</small>	COVE STANDARD CORD LENGTH = 108"	
	<b>36"</b>	+ \$5.50
	<b>72"</b>	+ \$5.50
	<b>144"</b>	+ \$7.50
	<b>180"</b>	+ \$10.00

ETL Listed

**NOTE:** One Time \$295.00  
Custom Cord Length Fee  
for all non-standard cord  
length requests

**PRODUCT INFORMATION:**

Product Dimensions: See Specification and Ordering Information

Standard Cord Length: 108"



Table Thickness..... .75"- 1.25"

Table Cutout.....See Installation Instructions



Innovative Power + Data Solutions

10 Mountain View Drive • Shelton, CT 06484 • P:800.521.3175 • F:203.924.6687 • www.electri-cable.com

# DAISYLINK™ SYSTEM – POWER INFEED OPTIONS AND INTERCONNECTING CABLES

INTERCONNECTING CABLES	PART NUMBER	DESCRIPTION	LIST PRICE
	42FF- LENGTH*	Female/ Female Interconnecting Cables	\$70.00+ \$1.075 per inch
	42FM- LENGTH*	Female/Male Interconnecting Cables	\$72.50 + \$1.075 per inch

\*Minimum 12”

POWER INFEED OPTIONS	PART NUMBER	DESCRIPTION	LIST PRICE
	42SB2- LENGTH	Multi-Circuit Hardwire Power Infeed	\$58.75 + .21 per inch
	42 QD INSERT	Insert for Floor Box and Wall Outlet Applications. Fits Standard Decora© Opening.	\$115.00
	4220AP1-72*	Single Circuit 20 AMP Power Infeed with 72” Molded Plug	\$211.85

\*Cannot exceed 72”

POWER MANAGER	PART NUMBER	DESCRIPTION	LIST PRICE
	DAISY-T	Daisy-T Power manager	\$145.00

CABLE COVERS	PART NUMBER	DESCRIPTION	LIST PRICE
	Add a “B” to the end of an existing DaisyLink Quick Kit. i.e VIF-4-1-P-B-36KB	Cable Covers added to any 4 wire 2 circuit Quick Kit	\$22.50 per kit
	Add a “B” to the end of cabling length. i.e 42 AP1-72B or 42 SB2-72B	All 72” power cords	\$22.50 per cord
	Add a “B” to the end of cabling length. i.e 42 FF-27B	Cable Covers added to individual interconnecting or starter cables	\$5.00 per foot

UL Listed & CSA Certified

Innovative Power + Data Solutions

10 Mountain View Drive • Shelton, CT 06484 • P:800.521.3175 • F:203.924.6687 • www.electri-cable.com



# DAISYLINK™ SYSTEM — COVE™ SERIES

## Power Only– Quick Kits— Single & Double

Blending power and USB with versatility.

### Single Kit Includes:

(COV-2 unit shown, see below for all available configurations)

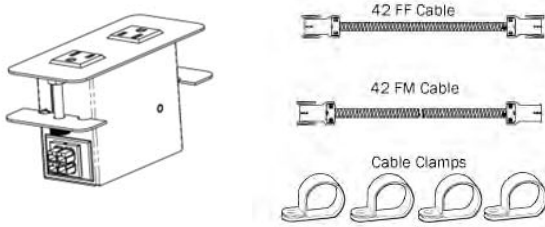

Replace \_\_\_\_ in Single Kit Part Number (K) with 36", 42", 48", 54", 60" or 72" for table length being specified. Pricing is standard for all table lengths.

### Double Kit Includes:

(COV-2 units shown, see below for all available configurations)

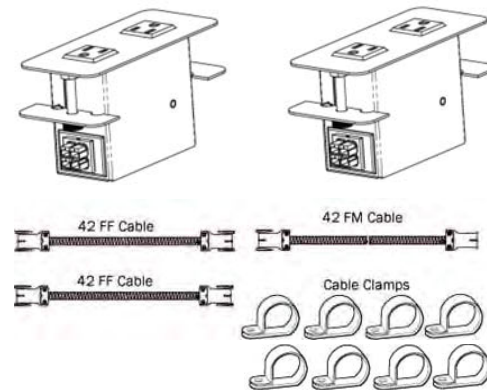

Replace \_\_\_\_ in Double Kit Part Number (DK) with 60", 72", 84", or 96" for table length being specified. Pricing is standard for all table lengths.

**Note:** Cable lengths are 1" longer than the table. Cables extend 1/2" off either side of the table for easy connection.

2 POWER	PART NUMBER	FINISH	LIST PRICE
	COV-2-41-S-__K COV-2-41-S-__DK	Silver	\$392.50 \$695.00
	COV-2-41-B-__K COV-2-41-B-__DK	Black	\$392.50 \$695.00
	COV-2-41-GW-__K COV-2-41-GW-__DK	Gloss White	\$392.50 \$695.00
	COV-2-41-AL-__K COV-2-41-AL-__DK	Aluminum	\$462.50 \$832.50
4 POWER	PART NUMBER	FINISH	LIST PRICE
	COV-4-41-S-__K COV-4-41-S-__DK	Silver	\$550.00 \$1,010.00
	COV-4-41-B-__K COV-4-41-B-__DK	Black	\$550.00 \$1,010.00
	COV-4-41-GW-__K COV-4-41-GW-__DK	Gloss White	\$550.00 \$1,010.00
	COV-4-41-AL-__K COV-4-41-AL-__DK	Aluminum	\$620.00 \$1,147.50

### PRODUCT INFORMATION:

Product Dimensions: See Specification and Ordering Information

Table Thickness..... .75"- 1.25"

Table Cutout.....See Installation Instructions

-See page 38 for Starter Cable and Interconnecting Cable Options.

-Change the "1" to a "2" to Specify Circuit 2 .

ETL and cETLus Certified

Innovative Power + Data Solutions

10 Mountain View Drive • Shelton, CT 06484 • P:800.521.3175 • F:203.924.6687 • www.electri-cable.com

# DAISYLINK™ SYSTEM — COVE™ SERIES

## Power and USB Charging— Quick Kits— Single & Double (Cont.)

Blending power and USB with versatility.

**Single Kit Includes:**

(COV-2U unit shown, see below for all available configurations)

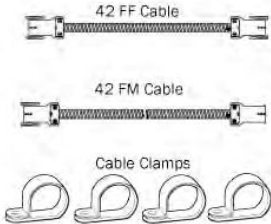
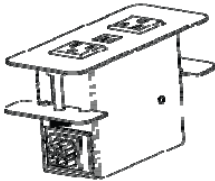

Replace \_\_\_\_ in Single Kit Part Number (K) with 36", 42", 48", 54", 60" or 72" for table length being specified. Pricing is standard for all table lengths.

**Double Kit Includes:**

(COV-2U units shown, see below for all available configurations)

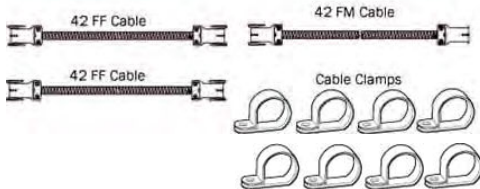
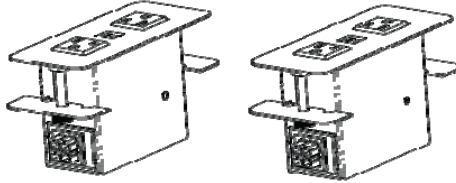

Replace \_\_\_\_ in Double Kit Part Number (DK) with 60", 72", 84", or 96" for table length being specified. Pricing is standard for all table lengths.

**Note:** Cable lengths are 1" longer than the table. Cables extend 1/2" off either side of the table for easy connection.

2 POWER , (2) 2.1 AMP USB CHARGING PORTS	PART NUMBER	FINISH	LIST PRICE
	COV-2U-41-S-__K COV-2U-41-S-__DK	Silver	\$485.00 \$892.50
	COV-2U-41-B-__K COV-2U-41-B-__DK	Black	\$485.00 \$892.50
	COV-2U-41-GW-__K COV-2U-41-GW-__DK	Gloss White	\$485.00 \$892.50
	COV-2U-41-AL-__K COV-2U-41-AL-__DK	Aluminum	\$555.00 \$1,030.00

4 POWER , (2) 2.1 AMP USB CHARGING PORTS	PART NUMBER	FINISH	LIST PRICE
	COV-4U-41-S-__K COV-4U-41-S-__DK	Silver	\$667.50 \$1,245.00
	COV-4U-41-B-__K COV-4U-41-B-__DK	Black	\$667.50 \$1,245.00
	COV-4U-41-GW-__K COV-4U-41-GW-__DK	Gloss White	\$667.50 \$1,245.00
	COV-4U-41-AL-__K COV-4U-41-AL-__DK	Aluminum	\$737.50 \$1,385.00

**PRODUCT INFORMATION:**

Product Dimensions: See Specification and Ordering Information  
 Table Thickness..... .75" - 1.25"  
 Table Cutout.....See Installation Instructions  
 -See page 38 for Starter Cable and Interconnecting Cable Options.  
 -Change the "1" to a "2" to Specify Circuit 2 .

ETL and cETLus Certified



Innovative Power + Data Solutions





10 Mountain View Drive • Shelton, CT 06484 • P:800.521.3175 • F:203.924.6687 • www.electri-cable.com



# DAISYLINK™ SYSTEM — COVE™ SERIES

**Build Your Own Options**  
Blending power and USB with versatility.

POWER ONLY	PART NUMBER	CONFIGURATION	FINISH	LIST PRICE
	COV-1-4-1-GW COV-1-4-1-S COV-1-4-1-B COV-1-4-1-AL	1 power, Circuit 1	Gloss White Silver Black Aluminum	\$182.50 \$182.50 \$182.50 \$252.50
	COV-2-4-1-GW COV-2-4-1-S COV-2-4-1-B COV-2-4-1-AL	2 power, Circuit 1	Gloss White Silver Black Aluminum	\$210.00 \$210.00 \$210.00 \$277.50
	COV-3-4-1-GW COV-3-4-1-S COV-3-4-1-B COV-3-4-1-AL	3 power, Circuit 1	Gloss White Silver Black Aluminum	\$340.00 \$340.00 \$340.00 \$410.00
	COV-4-4-1-GW COV-4-4-1-S COV-4-4-1-B COV-4-4-1-AL	4 power, Circuit 1	Gloss White Silver Black Aluminum	\$380.00 \$380.00 \$380.00 \$450.00

POWER AND USB	PART NUMBER	CONFIGURATION	FINISH	LIST PRICE
	COV-1U-4-1-GW COV-1U-4-1-S COV-1U-4-1-B COV-1U-4-1-AL	1 power, (2) 2.1 Amp USB charging ports, Circuit 1	Gloss White Silver Black Aluminum	\$300.00 \$300.00 \$300.00 \$370.00
	COV-2U-4-1-GW COV-2U-4-1-S COV-2U-4-1-B COV-2U-4-1-AL	2 power, (2) 2.1 Amp USB charging ports, Circuit 1	Gloss White Silver Black Aluminum	\$315.00 \$315.00 \$315.00 \$382.50
	COV-3U-4-1-GW COV-3U-4-1-S COV-3U-4-1-B COV-3U-4-1-AL	3 power, (2) 2.1 Amp USB charging ports, Circuit 1	Gloss White Silver Black Aluminum	\$420.00 \$420.00 \$420.00 \$487.50
	COV-4U-4-1-GW COV-4U-4-1-S COV-4U-4-1-B COV-4U-4-1-AL	4 power, (2) 2.1 Amp USB charging ports, Circuit 1	Gloss White Silver Black Aluminum	\$485.00 \$485.00 \$485.00 \$555.00

ETL and cETLus Certified

**PRODUCT INFORMATION:**

Product Dimensions: See Specification and Ordering Information

Table Thickness..... .75”- 1.25”

Table Cutout.....See Installation Instructions

-See page 38 for Starter Cable and Interconnecting Cable Options.

-Change the “1” to a “2” to Specify Circuit 2.

-Each Cove unit comes with 4 cable clamps and mounting screws.

Innovative Power + Data Solutions



10 Mountain View Drive • Shelton, CT 06484 • P:800.521.3175 • F:203.924.6687 • www.electri-cable.com

# DAISYLINK™ SYSTEM — COVE™ SERIES

## Build Your Own Options (Cont.)

Blending power and USB with versatility.

\*Telecom Plates sold separately, see page 100

POWER, USB, AND DATA	PART NUMBER	CONFIGURATION	FINISH	LIST PRICE
	COV-2U-4-1-D-GW COV-2U-4-1-D-S COV-2U-4-1-D-B COV-2U-4-1-D-AL	2 power, (2) 2.1 Amp USB charging ports, 1 Telecom Plate Cutout, Circuit 1	Gloss White Silver Black Aluminum	\$315.00 \$315.00 \$315.00 \$382.50
	COV-3U-4-1-D-GW COV-3U-4-1-D-S COV-3U-4-1-D-B COV-3U-4-1-D-AL	3 power, (2) 2.1 Amp USB charging ports, 1 Telecom Plate Cutout, Circuit 1	Gloss White Silver Black Aluminum	\$420.00 \$420.00 \$420.00 \$487.50
	COV-4U-4-1-D-GW COV-4U-4-1-D-S COV-4U-4-1-D-B COV-4U-4-1-D-AL	4 power, (2) 2.1 Amp USB charging ports, 1 Telecom Plate Cutout, Circuit 1	Gloss White Silver Black Aluminum	\$485.00 \$485.00 \$485.00 \$555.00

ETL and cETLus Certified

**PRODUCT INFORMATION:**

Product Dimensions: See Specification and Ordering Information

Table Thickness..... .75”- 1.25”

Table Cutout.....See Installation Instructions

-See page 38 for Starter Cable and Interconnecting Cable Options.

-Change the “1” to a “2” to Specify Circuit 2 .

# COVE TR—CORDED & DAISYLINK

Tamper Resistant Solution

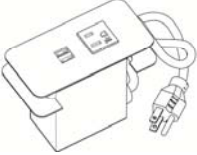
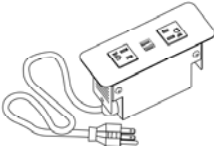
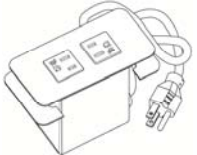
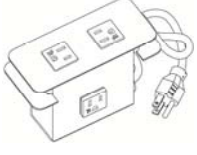
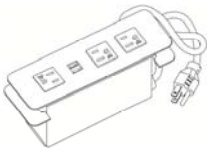
Cove TR Corded				
	PART NUMBER	DESCRIPTION	FINISH	LIST PRICE
	COV-TR-1U-B-108	1 Power, 2 USB, 108" Cord	Black	\$315.00
	COV-TR-1U-S-108		Silver Pearl	\$315.00
	COV-TR-1U-GW108		Gloss White	\$315.00
	COV-TR-1U-AL108		Brushed & Clear Anodized Aluminum	\$382.50
	COV-TR-2U-B-108	2 Power, 2 USB, 108" Cord	Black	\$327.50
	COV-TR-2U-S-108		Silver Pearl	\$327.50
	COV-TR-2U-GW108		Gloss White	\$327.50
	COV-TR-2U-AL108		Brushed & Clear Anodized Aluminum	\$397.50
	COV-TR-2-B-108	2 Power, 108" Cord	Black	\$247.50
	COV-TR-2-S-108		Silver Pearl	\$247.50
	COV-TR-2-GW108		Gloss White	\$247.50
	COV-TR-2-AL108		Brushed & Clear Anodized Aluminum	\$317.50
	COV-TR-21-B-108	2 Power, 1 Convenience, 108" Cord	Black	\$262.50
	COV-TR-21-S-108		Silver Pearl	\$262.50
	COV-TR-21-GW108		Gloss White	\$262.50
	COV-TR-21-AL108		Brushed & Clear Anodized Aluminum	\$330.00
	COV-TR-3U-B-108	3 Power, 2 USB, 108" Cord	Black	\$380.00
	COV-TR-3U-S-108		Silver Pearl	\$380.00
	COV-TR-3U-GW108		Gloss White	\$380.00
	COV-TR-3U-AL108		Brushed & Clear Anodized Aluminum	\$527.50

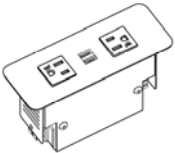
Cove TR DaisyLink				
	PART NUMBER	DESCRIPTION	FINISH	LIST PRICE
	COV-TR-2U-41-B	2 Power, 2 USB, Circuit 1	Black	\$327.50
	COV-TR-2U-41-S		Silver Pearl	\$327.50
	COV-TR-2U-41-GW		Gloss White	\$327.50
	COV-TR-2U-41-AL		Brushed & Clear Anodized Aluminum	\$397.20

CORD LENGTH OPTION FEES	
COVE STANDARD CORD LENGTH = 108"	
36"	+ \$13.75
72"	+ \$13.75
144"	+ \$18.75
180"	+ \$25.00

**TABLE REQUIREMENTS:**

Product Dimensions.....See Specification and Ordering Information  
 Standard Cord Length.....108"  
 Minimum Table Thickness.....0.25"  
 Table Cutout.....Mounts Beneath The Table Surface

**NOTE:** One Time \$295.00 Custom Cord Length Fee for all non-standard cord length requests

ETL Listed

# DRIFTER™

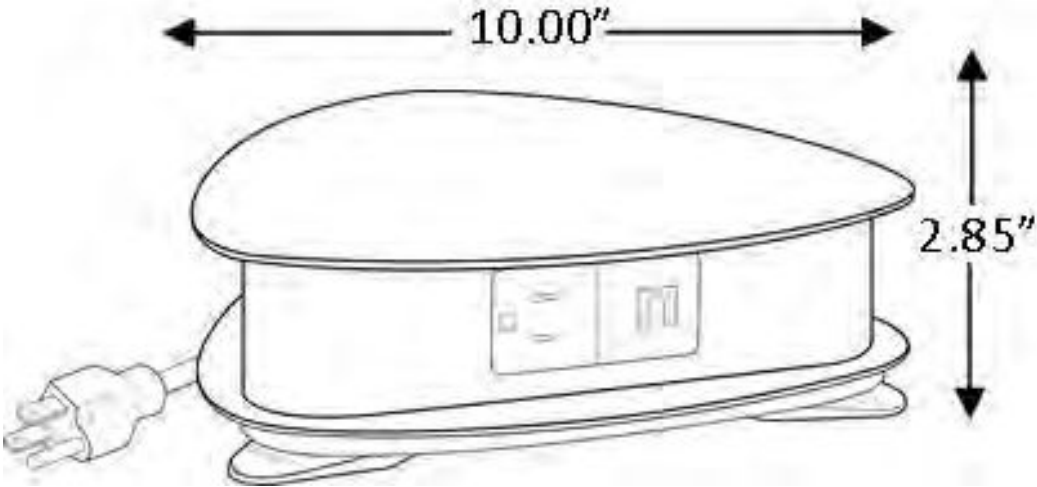

DRIFTER SERIES		
3 power, 6 2.1 AMP Active USB ports, 108" cord		
PART NUMBER	FINISH	LIST PRICE
DRI-GW-108	Gloss White	\$577.50
DRI-S-108	Silver Pearl	\$577.50
DRI-GB-108	Gloss Black	\$577.50

DRIFTER SPECIALTY COLORS		
PART NUMBER	FINISH	LIST PRICE
DRI-LG DRI-LB DRI-SR DRI-PO DRI-SY DRI-TX	Light Green- RAL 6027 Light Blue- RAL 5012 Signal Red- RAL 3001 Pure Orange- RAL 2004 Sulfur Yellow- RAL 1016 Tuxedo- Gloss Black with White Receptacles	\$597.50

**PRODUCT INFORMATION:**

Tuxedo Color Description: Gloss Black Unit with White Receptacles  
 Standard Cord Length: 108"  
 White Receptacles on All Colors  
 White Power Cords on All Colors Except Tuxedo

ETL Listed

# DEPARTURE WITH FLEXIBLE MOUNTING SOLUTIONS

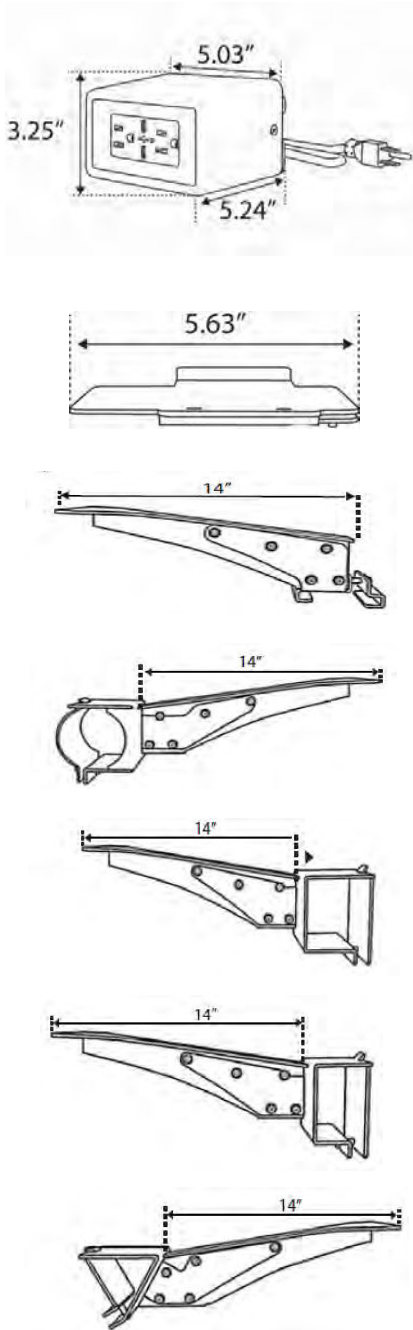

**PRODUCT INFORMATION:**

Standard Finish Options: Textured Black or Textured Grey Cover

Standard Cord Length for Arm Brackets: 96" Cord

Standard Arm-to-Clamp Bracket Length: 14"L

Custom Arm Lengths Available—Provide Seating Dimensions for Accurate Sizing

Daisy Chain Compatible

DESCRIPTION	PART NUMBER	FINISH	LIST PRICE
<b>UNDER-MOUNT—96" Cord</b>			
2 power, 2 USB	DEP-FL8-2U-B96 DEP-FL8-2U-GY96	BLACK GREY	Call For Pricing
<b>"T" SHAPE ARM MOUNT—96" Cord</b>			
2 Power, 2 USB	DEP-T14-2U-B96 DEP-T14-2U-GY96	BLACK GREY	Call For Pricing
2 Power, 1 USB, 1 USB-C	DEP-T142UACB96 DEP-T142UAGY96	BLACK GREY	
2 Power, 2 USB-C	DEP-T142U2CB96 DEP-T142U2CGY96	BLACK GREY	
<b>ROUND ARM MOUNT—96" Cord</b>			
2 Power, 2 USB	DEP-RD14-2U-B96 DEP-RD14-2U-GY96	BLACK GREY	Call For Pricing
2 Power, 1 USB, 1 USB-C	DEP-RD142UACB96 DEPRD142UCGY96	BLACK GREY	
2 Power, 2 USB-C	DEP-RD142U2CB96 DEPRD142U2CGY96	BLACK GREY	
<b>SQUARE ARM MOUNT—96" Cord</b>			
2 Power, 2 USB	DEP-SQ14-2U-B96 DEP-SQ14-2U-GY96	BLACK GREY	Call For Pricing
2 Power, 1 USB, 1 USB-C	DEP-SQ142UACB96 DEPSQ142UACGY96	BLACK GREY	
2 Power, 2 USB-C	DEP-SQ142U2CB96 DEPSQ142U2CGY96	BLACK GREY	
<b>RECTANGULAR ARM MOUNT—96" Cord</b>			
2 Power, 2 USB	DEP-RC142U-B96 DEP-RC142U-GY96	BLACK GREY	Call For Pricing
2 Power, 1 USB, 1 USB-C	DEP-RC142UACB96 DEPRC142UACGY96	BLACK GREY	
2 Power, 2 USB-C	DEP-RC142U2CB96 DEPRC142U2CGY96	BLACK GREY	
<b>TRIANGULAR ARM MOUNT—96" Cord</b>			
2 Power, 2 USB	DEP-TR14-2U-B96 DEP-TR14-2U-GY96	BLACK GREY	Call For Pricing
2 Power, 1 USB, 1 USB-C	DEP-TR142UACB96 DEPTR142UACGY96	BLACK GREY	
2 Power, 2 USB-C	DEP-TR142U2CB96 DEPTR142U2CGY96	BLACK GREY	

ETL Listed

Innovative Power + Data Solutions

10 Mountain View Drive • Shelton, CT 06484 • P:800.521.3175 • F:203.924.6687 • www.electri-cable.com

# INTERACT G2

Accessorize Your Tabletop.

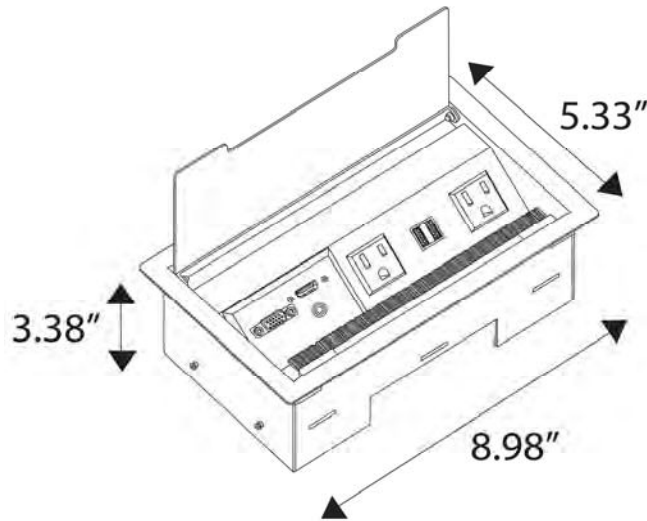

\*Telecom Plates sold separately, see page 100

PART NUMBER	CONFIGURATION	FINISH	LIST PRICE
ACT-21U-S-72 ACT-21U-B-72 ACT-21U-GW-72 ACT-21U-AL-72 ACT-21U-SS-72	2 Power Receptacles, 2 2.1amp USB, 1 Telecom Plate Cutout, Knockouts for 2 RJ45 Cat 6 Data, 2 Cord Pass Throughs, 1 Convenience Outlet, 72" Cord.	Silver Pearl Black Gloss White Brushed and Anodized Aluminum Brushed Stainless Steel	\$447.50 \$447.50 \$447.50 \$695.00 \$712.50
ACT-21U-S-HW-72 ACT-21U-B-HW-72 ACT-21U-GW-HW72 ACT-21U-AL-HW72 ACT-21U-SS-HW72	2 Power Receptacles, 2 2.1amp USB, 1 Telecom Plate Cutout, Knockouts for 2 RJ45 Cat 6 Data, 2 Cord Pass Throughs, 1 Convenience Outlet, 72" Hardwire.	Silver Pearl Black Gloss White Brushed and Anodized Aluminum Brushed Stainless Steel	\$472.50 \$472.50 \$472.50 \$720.00 \$735.00
ACT-21-S-72 ACT-21-B-72 ACT-21-GW-72 ACT-21-AL-72 ACT-21-SS-72	2 Power Receptacles, 1 Telecom Plate Cutout, Knockouts for 2 RJ45 Cat 6 Data, 2 Cord Pass Throughs, 1 Convenience Outlet, 72" Cord.	Silver Pearl Black Gloss White Brushed and Anodized Aluminum Brushed Stainless Steel	\$370.00 \$370.00 \$370.00 \$615.00 \$635.00
ACT-21-S-HW-72 ACT-21-B-HW-72 ACT-21-GW-HW-72 ACT-21-AL-HW-72 ACT-21-SS-HW-72	2 Power Receptacles, 1 Telecom Plate Cutout, Knockouts for 2 RJ45 Cat 6 Data, 2 Cord Pass Throughs, 1 Convenience Outlet, 72" Hardwire.	Silver Pearl Black Gloss White Brushed and Anodized Aluminum Brushed Stainless Steel	\$398.50 \$398.50 \$398.50 \$642.50 \$655.00

CORD LENGTH OPTION FEES	
INTERACT G2 STANDARD LENGTH = 72"	
36"	+ \$13.75
108"	+ \$13.75
144"	+ \$18.75
180"	+ \$25.00

**NOTE:** One Time \$295.00 Custom Cord Length Fee for all non-standard cord length requests

ETL Listed

**PRODUCT INFORMATION:**

Unit Depth..... 3.38"  
 Maximum Table Thickness..... 2"  
 Table Cutout.....8.38" x 4.75"

Innovative Power + Data Solutions

10 Mountain View Drive • Shelton, CT 06484 • P:800.521.3175 • F:203.924.6687 • www.electri-cable.com



# INTERACT G2 UT

Accessorize Your Tabletop.

## UNDERTABLE SOLUTIONS

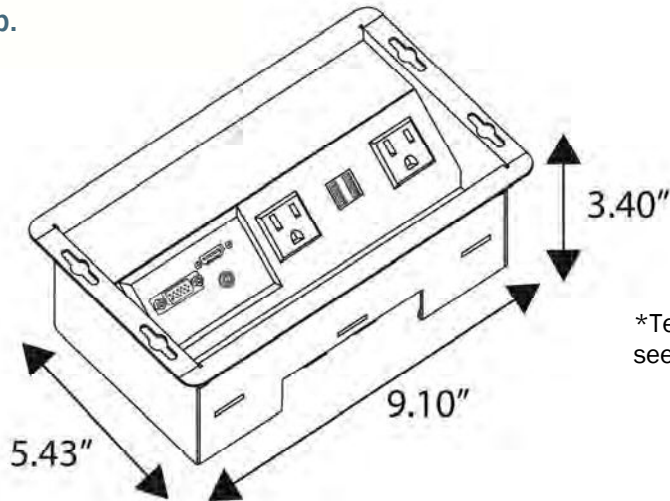

\*Telecom Plates sold separately, see page 100

PART NUMBER	CONFIGURATION	FINISH	LIST PRICE
ACT-UT-21U-S-72 ACT-UT-21U-B-72 ACT-UT-21U-GW72	Interact G2 UT, 2 Power, 1 Convenience Outlet, 2 2.1 amp USB, 1 Telecom Plate Knockout, 2 RJ45 Cat 6 Data Knockouts, 2 Cord Pass Throughs, 72" Cord	Silver Pearl Black Gloss White	\$437.50
ACT-UT-21USHW72 ACT-UT-21UBHW72 ACT-UT21UGWHW72	Interact G2 UT, 2 Power, 1 Convenience Outlet, 2 2.1 amp USB, 1 Telecom Plate Knockout, 2 RJ45 Cat 6 Data Knockouts, 2 Cord Pass Throughs, 72" Hardwire	Silver Pearl Black Gloss White	\$462.50
ACT-UT-21-S-72 ACT-UT-21-B-72 ACT-UT-21-GW-72	Interact G2 UT, 2 Power, 1 Convenience Outlet, 1 Telecom Plate Knockout, 2 RJ45 Cat 6 Data Knockouts, 2 Cord Pass Throughs, 72" Cord	Silver Pearl Black Gloss White	\$357.50
ACT-UT-21-SHW72 ACT-UT-21-BHW72 ACT-UT-21GWHW72	Interact G2 UT, 2 Power, 1 Convenience Outlet, 1 Telecom Plate Knockout, 2 RJ45 Cat 6 Data Knockouts, 2 Cord Pass Throughs, 72" Hardwire	Silver Pearl Black Gloss White	\$385.00

INTERACT G2 UT ACCESSORIES			
PART NUMBER	CONFIGURATION	FINISH	LIST PRICE
INTERACT UT LPA	Lid Pivot Assembly	Brushed Aluminum	\$317.50
INTERACT UT LG2 INTERACT UT LA	Interact Lid for use with Lid Pivot Assembly	Frosted Glass Brushed Aluminum	\$145.00 \$232.50

CORD LENGTH OPTION FEES	
INTERACT G2 UT STANDARD LENGTH = 72"	
36"	+\$13.75
108"	+\$13.75
144"	+\$18.75
180"	+\$25.00

**NOTE:** One Time \$295.00 Custom Cord Length Fee for all non-standard cord length requests

ETL Listed

**PRODUCT INFORMATION:**

Unit Depth..... 3.40"  
Table Cutout..... 8.00" x 4.50"

**Innovative Power + Data Solutions**

10 Mountain View Drive • Shelton, CT 06484 • P:800.521.3175 • F:203.924.6687 • [www.electri-cable.com](http://www.electri-cable.com)

# INTERACT IV G2

Accessorize Your Tabletop.

## TABLETOP SOLUTIONS

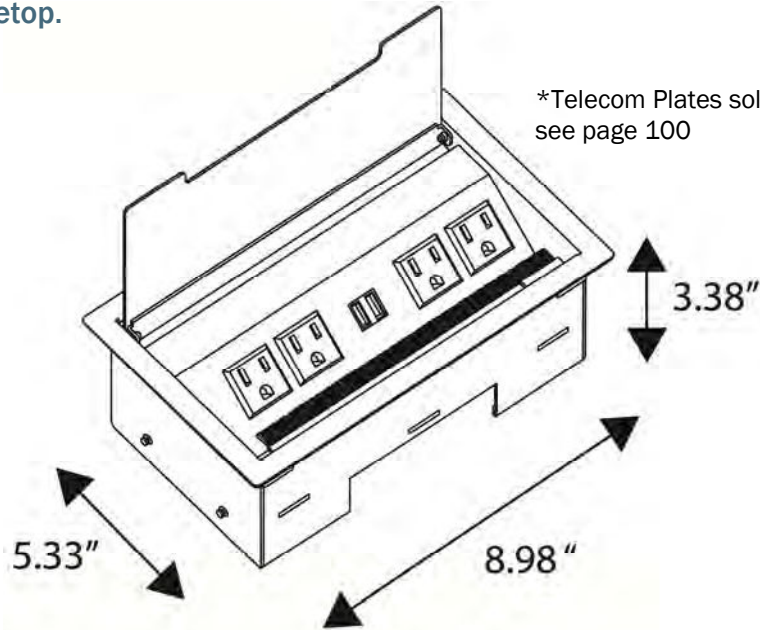

\*Telecom Plates sold separately, see page 100

PART NUMBER	CONFIGURATION	FINISH	LIST PRICE
ACT-41U-S-72 ACT-41U-B-72 ACT-41U-GW-72 ACT-41U-AL-72 ACT-41U-SS-72	4 Power Receptacles, 2 2.1amp USB, Knockouts for 2 RJ45 Cat 6 Data, 2 Cord Pass Throughs, 1 Convenience Outlet, 72" Cord.	Silver Pearl Black Gloss White Brushed and Anodized Aluminum Brushed Stainless Steel	\$630.00 \$630.00 \$630.00 \$875.00 \$892.50
ACT-41U-S-HW-72 ACT-41U-B-HW-72 ACT-41U-GW-HW72 ACT-41U-AL-HW72 ACT-41U-SS-HW72	4 Power Receptacles, 2 2.1amp USB, Knockouts for 2 RJ45 Cat 6 Data, 2 Cord Pass Throughs, 1 Convenience Outlet, 72" Hardwire.	Silver Pearl Black Gloss White Brushed and Anodized Aluminum Brushed Stainless Steel	\$655.00 \$655.00 \$655.00 \$902.50 \$917.50
ACT-41-S-72 ACT-41-B-72 ACT-41-GW-72 ACT-41-AL-72 ACT-41-SS-72	4 Power Receptacles, Knockouts for 2 RJ45 Cat 6 Data, 2 Cord Pass Throughs, 1 Convenience Outlet, 72" Cord.	Silver Pearl Black Gloss White Brushed and Anodized Aluminum Brushed Stainless Steel	\$550.00 \$550.00 \$550.00 \$797.50 \$812.50
ACT-41-S-HW-72 ACT-41-B-HW-72 ACT-41-GW-HW72 ACT-41-AL-HW72 ACT-41-SS-HW72	4 Power Receptacles, Knockouts for 2 RJ45 Cat 6 Data, 2 Cord Pass Throughs, 1 Convenience Outlet, 72" Hardwire.	Silver Pearl Black Gloss White Brushed and Anodized Aluminum Brushed Stainless Steel	\$577.50 \$577.50 \$577.50 \$822.50 \$840.00

### CORD LENGTH OPTION FEES

INTERACT IV G2 STANDARD LENGTH = 72"

36"	+ \$13.75
108"	+ \$13.75
144"	+ \$18.75
180"	+ \$25.00

### PRODUCT INFORMATION:

Unit Depth..... 3.38"  
Maximum Table Thickness..... 2"  
Table Cutout.....8.38" x 4.75"

**NOTE:** One Time \$295.00 Custom Cord Length Fee for all non-standard cord length requests

ETL Listed

Innovative Power + Data Solutions

10 Mountain View Drive • Shelton, CT 06484 • P:800.521.3175 • F:203.924.6687 • www.electri-cable.com



# INTERCEPT™

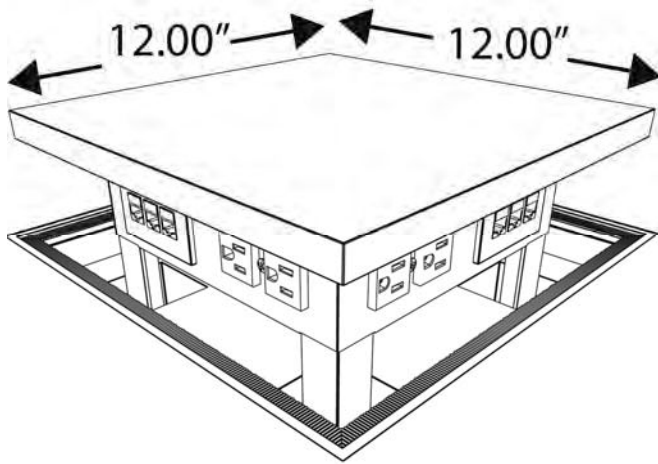

There When You Need It,  
Gone When You Don't.

**PART NUMBER KEY:**  
**INTERCEPT I**— Gas Spring Manual Lift  
**INTERCEPT 2**— Motorized Lift

\*Telecom Plates sold separately, see page 100  
 Intercept Lids sold separately.

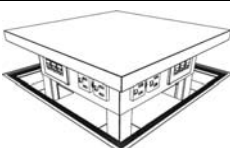
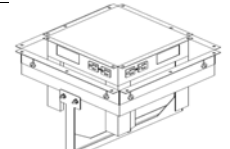
INTERCEPT	PART NUMBER	CONFIGURATION	CORD	LIST PRICE
	INTERCEPT I SC INTERCEPT I HW	Gas Spring Manual Lift, 8 Power Receptacles and Cutouts for 4 Telecom Plates.	72" Cord 72" Hardwire	\$2,022.50 \$2,047.50
	INTERCEPT 2 SC INTERCEPT 2 HW	Motorized Lift with Switch Box, 8 Power Receptacles and Cutouts for 4 Telecom Plates. Outer Pan Included	72" Cord 72" Hardwired	\$4,237.50 \$4,262.50

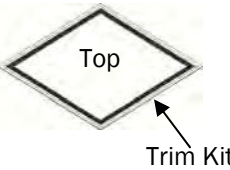
INTERCEPT ACCESSORIES	PART NUMBER	DESCRIPTION	FINISH	LIST PRICE
	AK 99 AK 99 SS INTERCEPT TOP BL INTERCEPT TOP SS	Trim Kit, Bezel with Wire Management Brush to Trim the Cutout, Intercept Top.	Black Brushed Stainless Steel Black Brushed Stainless Steel	\$247.50 \$447.50 \$152.50 \$515.00
	INTERCEPT OP	Outer Pan for Concealing Unit when not Installed in a Pedestal.	Black	\$142.50
	INTRCPT 2 SWTCH	Switch Box for Intercept 2	N/A	\$125.00

**TABLE REQUIREMENTS:**

Unit Depth ..... 10.15"  
 Maximum Table Thickness.....Between .656" x 1.625"  
 Table Cutout.....13.125" x 13.125"

Intercept 1- CSA Certified  
 Intercept 2- ETL Listed

# INTERFACE G2

Accessorize Your Tabletop.

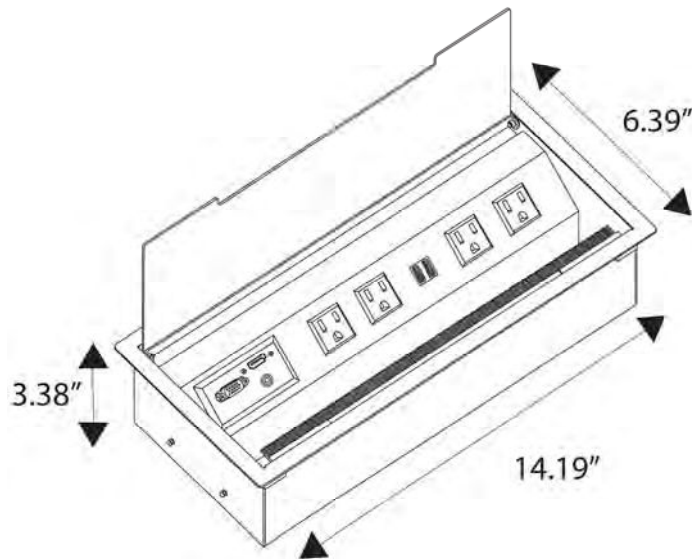

\*Telecom Plates sold separately, see page 100

PART NUMBER	CONFIGURATION	FINISH	LIST PRICE
INT-41U-S-72 INT-41U-B-72 INT-41U-GW-72 INT-41U-AL-72 INT-41U-SS-72	4 Power, 2 2.1amp USB, 3 Telecom Plate Cutouts, 1 Convenience Outlet, 72" Cord.	Silver Pearl Black Gloss White Brushed and Anodized Aluminum Brushed Stainless Steel	\$865.00 \$865.00 \$865.00 \$1,087.50 \$1,102.50
INT-41U-S-HW-72 INT-41U-B-HW-72 INT-41U-GW-HW72 INT-41U-AL-HW72 INT-41U-SS-HW72	4 Power, 2 2.1amp USB, 3 Telecom Plate Cutouts, 1 Convenience Outlet, 72" Hardwire.	Silver Pearl Black Gloss White Brushed and Anodized Aluminum Brushed Stainless Steel	\$892.50 \$892.50 \$892.50 \$1,115.00 \$1,127.50
INT-41-S-72 INT-41-B-72 INT-41-GW-72 INT-41-AL-72 INT-41-SS-72	4 Power, 3 Telecom Plate Cutouts, 1 Convenience Outlet, 72" Cord.	Silver Pearl Black Gloss White Brushed and Anodized Aluminum Brushed Stainless Steel	\$787.50 \$787.50 \$787.50 \$1,010.00 \$1,022.50
INT-41-S-HW-72 INT-41-B-HW-72 INT-41-GW-HW-72 INT-41-AL-HW-72 INT-41-SS-HW-72	4 Power, 3 Telecom Plate Cutouts, 1 Convenience Outlet, 72" Hardwire.	Silver Pearl Black Gloss White Brushed and Anodized Aluminum Brushed Stainless Steel	\$812.50 \$812.50 \$812.50 \$1,035.00 \$1,050.00

CORD LENGTH OPTION FEES	
INTERFACE G2 STANDARD LENGTH = 72"	
36"	+ \$13.75
108"	+ \$13.75
144"	+ \$18.75
180"	+ \$25.00

**NOTE:** One Time \$295.00 Custom Cord Length Fee for all non-standard cord length requests

ETL Listed

**PRODUCT INFORMATION:**

Unit Depth..... 3.38"  
 Maximum Table Thickness.....2"  
 Table Cutout.....6.00" x 13.63"

**Innovative Power + Data Solutions**

10 Mountain View Drive • Shelton, CT 06484 • P:800.521.3175 • F:203.924.6687 • www.electri-cable.com

# INTERFACE G2 UT

Accessorize Your Tabletop.

\*Telecom Plates sold separately, see page 100

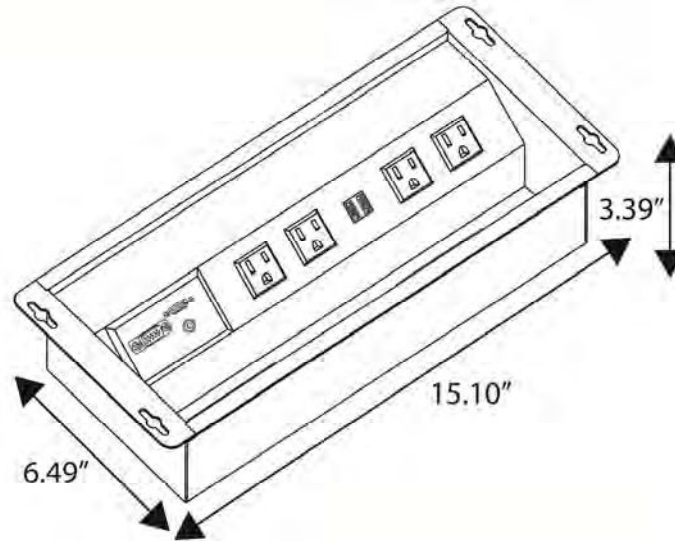

PART NUMBER	CONFIGURATION	FINISH	LIST PRICE
INT-UT-41U-S-72 INT-UT-41U-B-72 INT-UT-41U-GW72	Interface G2 UT, 4 Power, 1 Convenience Outlet, 2 2.1 amp USB, 3 Telecom Plate Knockouts, 72" Cord.	Silver Pearl Black Gloss White	\$740.00
INT-UT-41USHW72 INT-UT-41UBHW72 INT-UT41UGWHW72	Interface G2 UT, 4 Power, 1 Convenience Outlet, 2 2.1 amp USB, 3 Telecom Plate Knockouts, 72" Hardwire.	Silver Pearl Black Gloss White	\$765.00
INT-UT-41-S-72 INT-UT-41-B-72 INT-UT-41-GW72	Interface G2 UT, 4 Power, 1 Convenience Outlet, 3 Telecom Plate Knockouts, 72" Cord.	Silver Pearl Black Gloss White	\$660.00
INT-UT-41-SHW72 INT-UT-41-BHW72 INT-UT-41GWHW72	Interface G2 UT, 4 Power, 1 Convenience Outlet, 3 Telecom Plate Knockouts, 72" Hardwire.	Silver Pearl Black Gloss White	\$687.50

INTERFACE G2 UT ACCESSORIES			
PART NUMBER	CONFIGURATION	FINISH	LIST NET PRICE
INTRFC IUT LPA	Lid Pivot Assembly	Brushed Aluminum	\$317.50
INTRFC IUT LG2 INTRFC IUT LA	Interface Lid for use with Lid Pivot Assembly	Frosted Glass Brushed Aluminum	\$145.00 \$232.50

CORD LENGTH OPTIONS FEES	
INTERFACE G2 UT STANDARD LENGTH = 72"	
36"	+ \$13.75
108"	+ \$13.75
144"	+ \$18.75
180"	+ \$25.00

**NOTE:** One Time \$295.00 Custom Cord Length Fee for all non-standard cord length requests

ETL Listed

**PRODUCT INFORMATION:**

Unit Depth..... 3.39"  
Table Cutout..... 13.75" x 6.38"

Innovative Power + Data Solutions

10 Mountain View Drive • Shelton, CT 06484 • P:800.521.3175 • F:203.924.6687 • www.electri-cable.com

# INTERFACE II TT

Back-To-Back Power and Data.

**TABLETOP SOLUTIONS**

\*Telecom Plates sold separately, see page 100

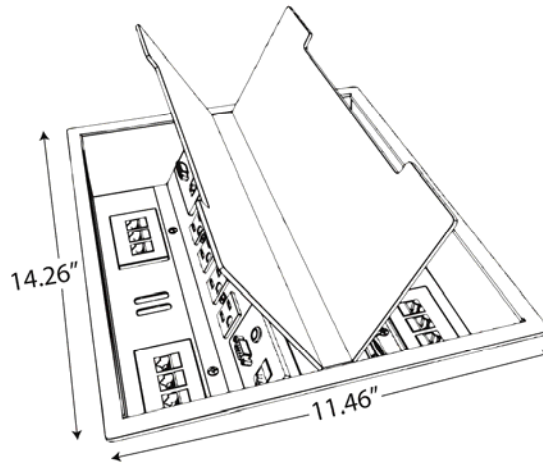

PART NUMBER	CONFIGURATION	FINISH	CORD	LIST PRICE
INTRFC II TT SC INTRFC II TT 06 INTRFC II TT 12 INT-II-TT-B180 INTRFC II TT HW INTRFC II TTHW4 INTRFC II TTHW5 INT-IITTBHW180	Double Sided Tabletop Unit with 8 Power Receptacles, 15 AMP Circuit breaker and Cutouts for 8 Telecom Plates.	Black Textured	72" Cord 108" Cord 144" Cord 180" Cord 72" Hardwire 108" Hardwire 144" Hardwire 180" Hardwire	\$1,087.50 \$1,101.25 \$1,106.25 \$1,112.50 \$1,112.50 \$1,126.25 \$1,131.25 \$1,137.50
INTRFC II TT CS INTRFC II TT 32 INTRFC II TT 33 INT-II-TT-SP180 INTRFC II TT HW6 INTRFC II TT HW7 INTRFC II TT HW8 INT-IITTSPhw180	Double Sided Tabletop Unit with 8 Power Receptacles, 15 AMP Circuit breaker and Cutouts for 8 Telecom Plates.	Silver Pearl	72" Cord 108" Cord 144" Cord 180" Cord 72" Hardwire 108" Hardwire 144" Hardwire 180" Hardwire	\$1,087.50 \$1,101.25 \$1,106.25 \$1,112.50 \$1,112.50 \$1,126.25 \$1,131.25 \$1,137.50
INTRFC II TT-ALSC INTRFC II TTAL01 INTRFC II TTAL02 INT-II-TT-AL180 INTRFC II TTAL03 INTRFC II TTAL04 INTRFC II TTAL05 INT-IITTALHW180	Double Sided Tabletop Unit with 8 Power Receptacles, 15 AMP Circuit breaker and Cutouts for 8 Telecom Plates.	Brushed and Anodized Aluminum	72" Cord 108" Cord 144" Cord 180" Cord 72" Hardwire 108" Hardwire 144" Hardwire 180" Hardwire	\$1,740.00 \$1,753.75 \$1,758.75 \$1,765.00 \$1,765.00 \$1,778.75 \$1,783.75 \$1,790.00
INTRFC II TT-SSSC INTRFC II TT SS01 INTRFC II TT 25 INT-II-TT-SS180 INTRFC II TT-SSHW INTRFC II TT SS02 INTRFC II TT SS03 INT-IITTSSHW180	Double Sided Tabletop Unit with 8 Power Receptacles, 15 AMP Circuit breaker and Cutouts for 8 Telecom Plates.	Brushed Stainless Steel	72" Cord 108" Cord 144" Cord 180" Cord 72" Hardwire 108" Hardwire 144" Hardwire 180" Hardwire	\$2,177.50 \$2,191.25 \$2,196.25 \$2,202.50 \$2,202.50 \$2,216.25 \$2,221.25 \$2,227.50

UL Listed and CSA Certified

**PRODUCT INFORMATION:**

Unit Depth ..... 2.84"  
 Table Thickness.....Between 0.875" - 2"  
 Table Cutout.....13.625" x 10.9375"

**Innovative Power + Data Solutions**

10 Mountain View Drive • Shelton, CT 06484 • P:800.521.3175 • F:203.924.6687 • www.electri-cable.com

# INTERFACE II TT WITH CONVENIENCE OUTLETS

Back-To-Back Power and Data.

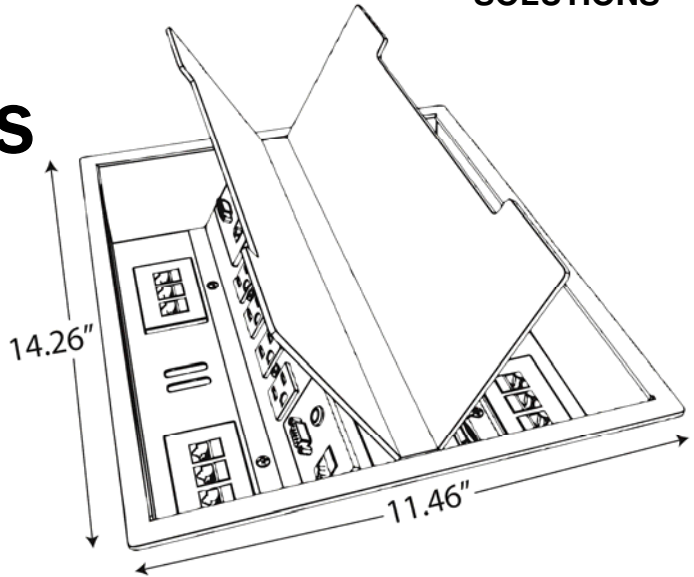

\*Telecom Plates sold separately, see page 100

PART NUMBER	CONFIGURATION	FINISH	CORD	LIST PRICE
INTRFC II TT DC INTRFC II TTDC1 INT-II-TTBDC144 INT-II-TTBDC180 INTRFC2 TTHWDC INTIITTBHWDC108 INTIITTBHWDC144 INTIITTBHWDC180	Double Sided Tabletop Unit with 8 Power Receptacles, 15 AMP Circuit breaker and Cutouts for 8 Telecom Plates. With convenience receptacle and underside of unit.	Black Textured	72" Cord 108" Cord 144" Cord 180" Cord 72" Hardwire 108" Hardwire 144" Hardwire 180" Hardwire	\$1,242.50 \$1,256.25 \$1,261.25 \$1,267.50 \$1,267.50 \$1,281.25 \$1,286.25 \$1,292.50
INT-II-TTSPDC72 INTRFC II TT DC2 INT-IITSPDC144 INT-IITSPDC180 INT-IITT-SPHWDC INTIITTSWDC108 INTIITTSWDC144 INTIITTSWDC180	Double Sided Tabletop Unit with 8 Power Receptacles, 15 AMP Circuit breaker and Cutouts for 8 Telecom Plates. With convenience receptacle and underside of unit.	Silver Pearl	72" Cord 108" Cord 144" Cord 180" Cord 72" Hardwire 108" Hardwire 144" Hardwire 180" Hardwire	\$1,242.50 \$1,256.25 \$1,261.25 \$1,267.50 \$1,267.50 \$1,281.25 \$1,286.25 \$1,292.50
INTRFC II TTALDC INTIITTDAL108 INTIITTDAL144 INTIITTDAL180 INTIITTDALCHW72 INTIITTDALHDC108 INTIITTDALHDC144 INTIITTDALHDC180	Double Sided Tabletop Unit with 8 Power Receptacles, 15 AMP Circuit breaker and Cutouts for 8 Telecom Plates. With convenience receptacle and underside of unit.	Brushed and Anodized Aluminum	72" Cord 108" Cord 144" Cord 180" Cord 72" Hardwire 108" Hardwire 144" Hardwire 180" Hardwire	\$1,775.00 \$1,788.75 \$1,793.75 \$1,800.00 \$1,800.00 \$1,813.75 \$1,818.75 \$1,825.00
INTRFC II TT 04 INTIITTSDC108 INTIITTSDC144 INTIITTSDC180 INTRFC II TT 03 INTIITSSHDC108 INTIITSSHDC144 INTIITSSHDC180	Double Sided Tabletop Unit with 8 Power Receptacles, 15 AMP Circuit breaker and Cutouts for 8 Telecom Plates. With convenience receptacle and underside of unit.	Brushed Stainless Steel	72" Cord 108" Cord 144" Cord 180" Cord 72" Hardwire 108" Hardwire 144" Hardwire 180" Hardwire	\$2,215.00 \$2,228.75 \$2,233.75 \$2,240.00 \$2,240.00 \$2,253.75 \$2,258.75 \$2,265.00

**PRODUCT INFORMATION:**

Unit Depth ..... 2.84"  
 Table Thickness.....Between 0.875" - 2"  
 Table Cutout.....13.625" x 10.9375"

UL Listed and CSA Certified

**Innovative Power + Data Solutions**

10 Mountain View Drive • Shelton, CT 06484 • P:800.521.3175 • F:203.924.6687 • www.electri-cable.com



# INTERFACE II UT

Double the Power, Double the Style

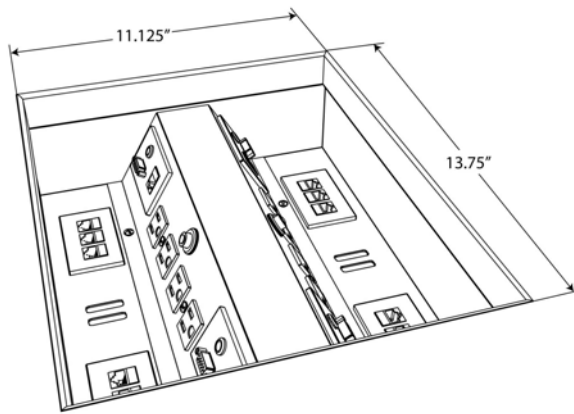

Interface II UT

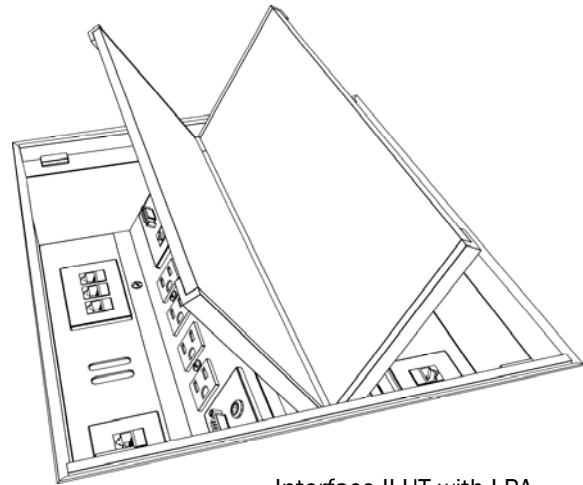

Interface II UT with LPA

\*Telecom Plates sold separately, see page 100

PART NUMBER	CONFIGURATION	CORD	FINISH	LIST PRICE
INTRFC II UT SC	Undertable Unit with 8 Power Receptacles, 15 AMP Circuit Breaker, and 8 Telecom Plate Cutouts.	72" Cord	Black Textured	\$737.50
INTRFC II UT O3		108" Cord		\$751.25
INTRFC II UT O4		144" Cord		\$756.25
INTRFC II UT O5		180" Cord		\$762.50
INTRFC II UT O7	Undertable Unit with 8 Power Receptacles, 15 AMP Circuit Breaker, and 8 Telecom Plate Cutouts.	72" Cord	Silver Pearl	\$760.00
INTRFC II UT O8		108" Cord		\$773.75
INTRFC II UT O9		144" Cord		\$778.75
INT-IIUT-SP-180		180" Cord		\$785.00

INTERFACE II UT ACCESSORIES	PART NUMBER	DESCRIPTION	FINISH	LIST PRICE
	INTRFC II UT LPA INTRFC II UT LA	Interface I Lid for use with Trim Pivot Kit	Brushed and Anodized Aluminum	\$465.00 \$637.50

CSA Certified

**TABLE REQUIREMENTS:**

Table Cutout.....13.75" x 11.125"

# INTERFACE II UT HARDWARE

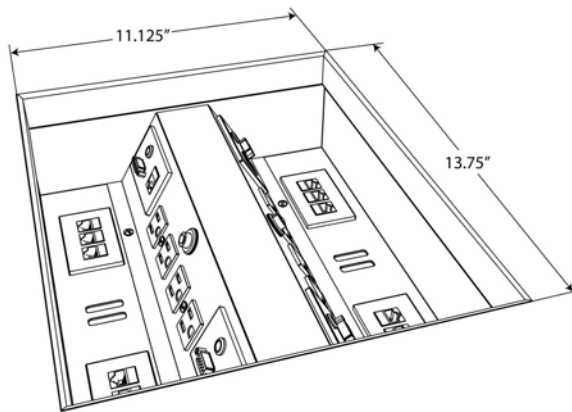

Interface II UT

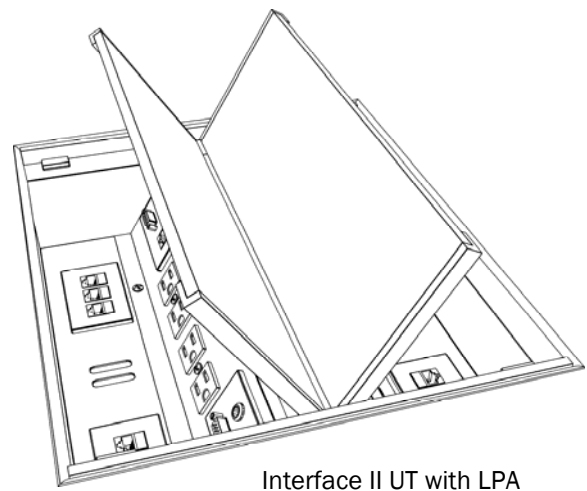

Interface II UT with LPA

\*Telecom Plates sold separately, see page 100

PART NUMBER	CONFIGURATION	CORD	FINISH	LIST PRICE
INTRFC II UT HW	Undertable Unit with 8 Power Receptacles, 15 AMP Circuit Breaker, and 8 Telecom Plate Cutouts.	72" Hardwire	Black Textured	\$762.50
INTRFC IIUTHW01		108" Hardwire		\$776.25
INTRFCIIUTHW144		144" Hardwire		\$781.25
INT-IIUTBLHW180		180" Hardwire		\$787.50
INTRFC IIUTHW03	Undertable Unit with 8 Power Receptacles, 15 AMP Circuit Breaker, and 8 Telecom Plate Cutouts.	72" Hardwire	Silver Pearl	\$762.50
INTRFC II UTHW04		108" Hardwire		\$776.25
INTRFC II UTHW05		144" Hardwire		\$781.25
INT-IIUTSPHW180		180" Hardwire		\$787.50

INTERFACE II UT ACCESSORIES	PART NUMBER	DESCRIPTION	FINISH	LIST PRICE
	INTRFC II UT LPA	Interface I Lid for use with Trim Pivot Kit	Brushed and Anodized Aluminum	\$465.00
	INTRFC II UT LA			\$637.50

**TABLE REQUIREMENTS:**

Table Cutout.....13.75" x 11.125"

# INTERFACE II UT WITH CONVENIENCE OUTLETS

Double the Power, Double the Style

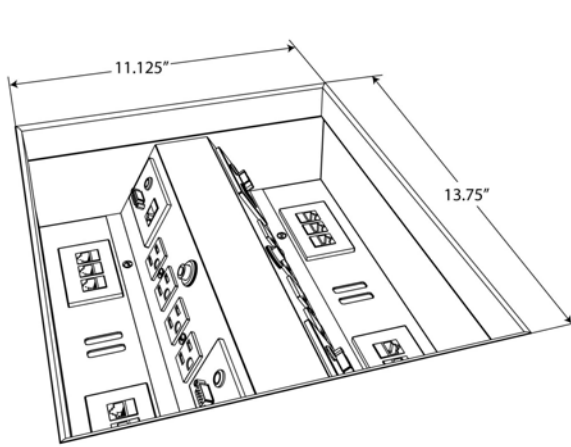

Interface II UT

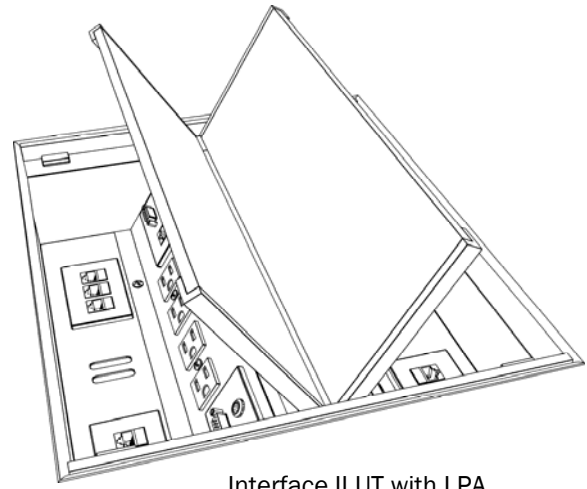

Interface II UT with LPA

\*Telecom Plates sold separately, see page 100

PART NUMBER	CONFIGURATION	CORD	FINISH	LIST PRICE
INTRFC2 UTSCDC	Undertable Unit with 8 Power Receptacles, 15 AMP Circuit Breaker, and 8 Telecom Plate Cutouts. With convenience receptacle and underside of unit.	72" Cord	Black Textured	\$875.00
INTFC2UTSCDC108		108" Cord		\$888.75
INTFC2UTSCDC144		144" Cord		\$893.75
INTFC2UTSCDC180		180" Cord		\$900.00
INT2UTSPSCDC72	Undertable Unit with 8 Power Receptacles, 15 AMP Circuit Breaker, and 8 Telecom Plate Cutouts. With convenience receptacle and underside of unit.	72" Cord	Silver Pearl	\$875.00
INT2UTSPSCDC108		108" Cord		\$888.75
INT2UTSPSCDC144		144" Cord		\$893.75
INT2UTSPSCDC180		180" Cord		\$900.00

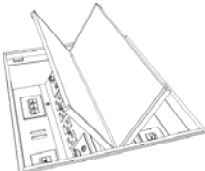
INTERFACE II UT ACCESSORIES	PART NUMBER	DESCRIPTION	FINISH	LIST PRICE
	INTRFC II UT LPA INTRFC II UT LA	Interface I Lid for use with Trim Pivot Kit	Brushed and Anodized Aluminum	\$465.00 \$637.50

**TABLE REQUIREMENTS:**

Table Cutout.....13.75" x 11.125"



# INTERFACE II UT HARDWIRE WITH CONVENIENCE OUTLETS

Double the Power, Double the Style

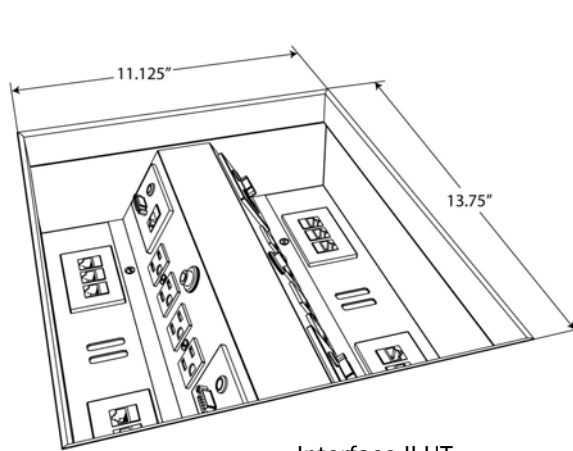

Interface II UT

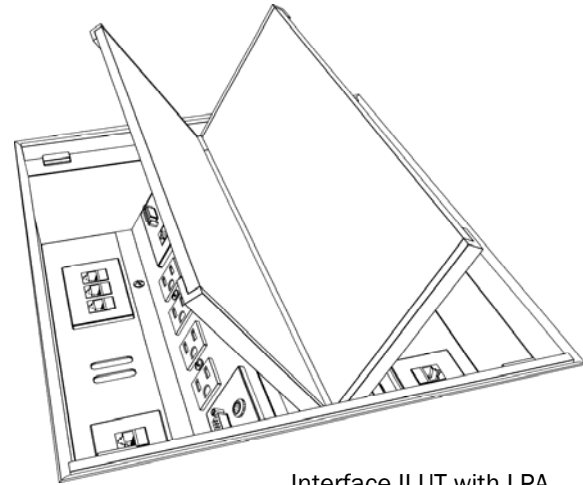

Interface II UT with LPA

\*Telecom Plates sold separately, see page 100

PART NUMBER	CONFIGURATION	CORD	FINISH	LIST PRICE
INTRFC2 UTHWDC	Undertable Unit with 8 Power Receptacles, 15 AMP Circuit Breaker, and 8 Telecom Plate Cutouts. With convenience receptacle and underside of unit.	72" Hardwire	Black Textured	\$900.00
INTRFC II UT 14		108" Hardwire		\$913.75
INT-2UTHWDC144		144" Hardwire		\$918.75
INT-2UTHWDC180		180" Hardwire		\$925.00
INT2UTSPHWDC72	Undertable Unit with 8 Power Receptacles, 15 AMP Circuit Breaker, and 8 Telecom Plate Cutouts. With convenience receptacle and underside of unit.	72" Hardwire	Silver Pearl	\$900.00
INT2UTSPHWDC108		108" Hardwire		\$913.75
INT2UTSPHWDC144		144" Hardwire		\$918.75
INT2UTSPHWDC180		180" Hardwire		\$925.00

INTERFACE II UT ACCESSORIES	PART NUMBER	DESCRIPTION	FINISH	LIST PRICE
	INTRFC II UT LPA	Interface I Lid for use with Trim Pivot Kit	Brushed and Anodized Aluminum	\$465.00
	INTRFC II UT LA			\$637.50

**TABLE REQUIREMENTS:**

Table Cutout.....13.75" x 11.125"

# ISLE™ G2

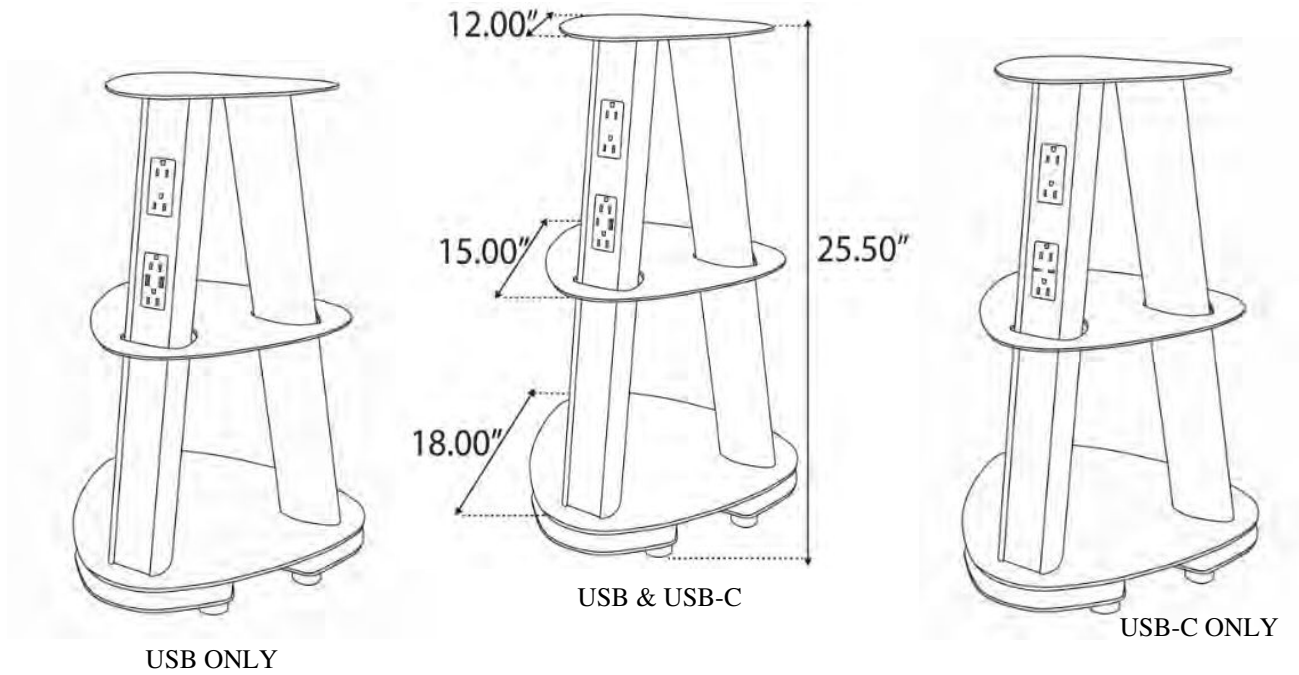

ISLE G2 SERIES			
CONFIGURATIONS	PART NUMBER	FINISH	LIST PRICE
(12) Tamper Resistant Power Receptacles, (6) USB charging ports and 108" cord	ISL-12U6A-GW108	Gloss White	\$1,705.00
	ISL-12U6A-GB108	Gloss Black	\$1,705.00
	ISL-12U6A-S108	Silver Pearl	\$1,705.00
(12) Tamper Resistant Power Receptacles, (3) USB and (3) USB-C charging ports and 108" cord	ISL-12U3AC-GW108	Gloss White	\$1,770.00
	ISL-12U3AC-GB108	Gloss Black	\$1,770.00
	ISL-12U3AC-S108	Silver Pearl	\$1,770.00
(12) Tamper Resistant Power Receptacles, (6) USB-C charging ports and 108" cord	ISL-12U6C-GW108	Gloss White	\$1,770.00
	ISL-12U6C-GB108	Gloss Black	\$1,770.00
	ISL-12U6C-S108	Silver Pearl	\$1,770.00

ETL Listed

# ISLE™ G2 (CONT.)

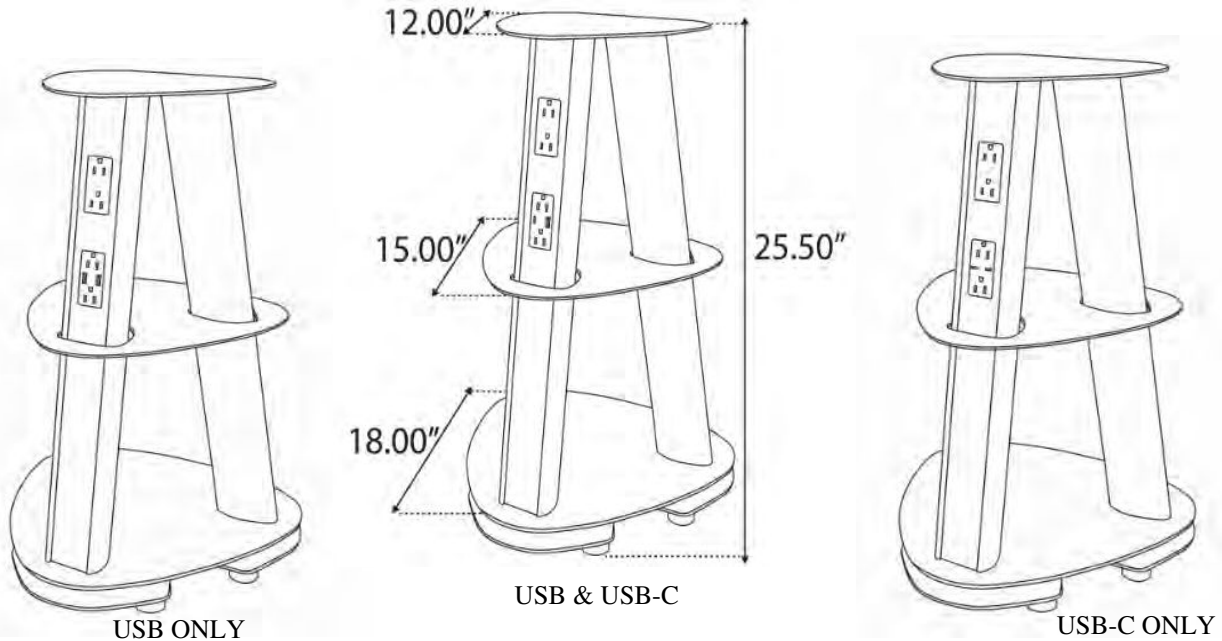

ISLE G2 SPECIALTY COLORS			
CONFIGURATION	PART NUMBER	FINISH	LIST PRICE
(12) Tamper Resistant Power Receptacles, (6) USB charging ports and 108" cord	ISL-12U6A-LB108 ISL-12U6A-LG108 ISL-12U6A-SY108 ISL-12U6A-PO108 ISL-12U6A-SR108 ISL-12U6A-TX108	Light Blue- RAL 5012 Light Green- RAL 6027 Sulfur Yellow- RAL 1016 Pure Orange- RAL 2004 Signal Red- RAL 3001 Tuxedo- Gloss Black with White Receptacles	\$1,770.00
(12) Tamper Resistant Power Receptacles, (3) USB and (3) USB-C charging ports and 108" cord	ISL-12U3ACLB108 ISL-12U3ACLG108 ISL-12U3ACSY108 ISL-12U3ACP0108 ISL-12U3ACSR108 ISL-12U3ACTX108	Light Blue- RAL 5012 Light Green- RAL 6027 Sulfur Yellow- RAL 1016 Pure Orange- RAL 2004 Signal Red- RAL 3001 Tuxedo- Gloss Black with White Receptacles	\$1,837.50
(12) Tamper Resistant Power Receptacles, (6) USB-C charging ports and 108" cord	ISL-12U6C-LB108 ISL-12U6C-LG108 ISL-12U6C-SY108 ISL-12U6C-PO108 ISL-12U6C-SR108 ISL-12U6C-TX108	Light Blue- RAL 5012 Light Green- RAL 6027 Sulfur Yellow- RAL 1016 Pure Orange- RAL 2004 Signal Red- RAL 3001 Tuxedo- Gloss Black with White Receptacles	\$1,837.50

**PRODUCT INFORMATION:**

Tuxedo Color Description: Gloss Black Unit with White Receptacles  
 Standard Cord Length: 108"  
 Isle Cord length Cannot Be Changed  
 White Receptacles on All Colors  
 White Power Cords on All Colors Except Tuxedo

ETL Listed

**Innovative Power + Data Solutions**

10 Mountain View Drive • Shelton, CT 06484 • P:800.521.3175 • F:203.924.6687 • [www.electri-cable.com](http://www.electri-cable.com)

# MARINA GROMMETS

Stylish Accessories.

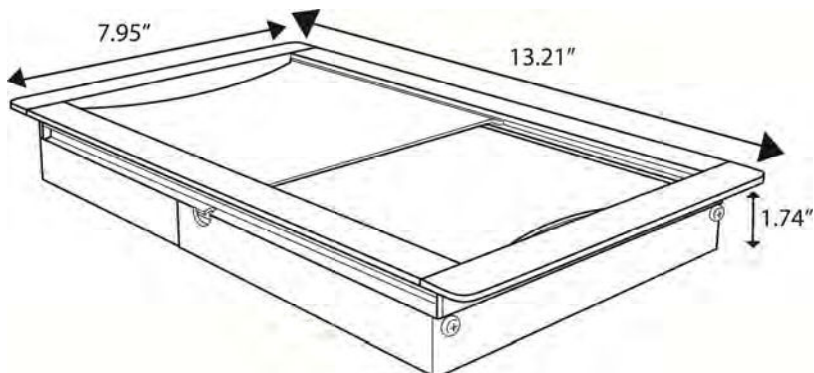

MARINA GROMMET

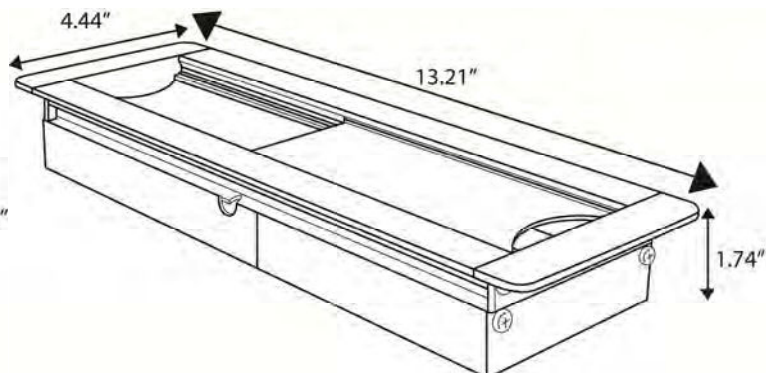

MARINA MINI GROMMET

MARINA GROMMETS	PART NUMBER	FINISH	LIST PRICE
	MAR-GROM-B	Black	\$287.50
	MAR-GROM-GW	Gloss White	\$287.50
	MAR-GROM-S	Silver Pearl	\$287.50
	MAR-GROM-AL	Aluminum	\$550.00

MARINA MINI GROMMETS	PART NUMBER	FINISH	LIST PRICE
	MAR-GROMS-B	Black	\$210.00
	MAR-GROMS-GW	Gloss White	\$210.00
	MAR-GROMS-S	Silver Pearl	\$210.00
	MAR-GROMS-AL	Aluminum	\$420.00

## TABLE REQUIREMENTS: MARINA GROMMETS

Table Cutout..... 12.125" x 7.5"

## TABLE REQUIREMENTS: MARINA MINI GROMMETS

Table Cutout..... 12.25" x 4"

# MARINA™ HDMI

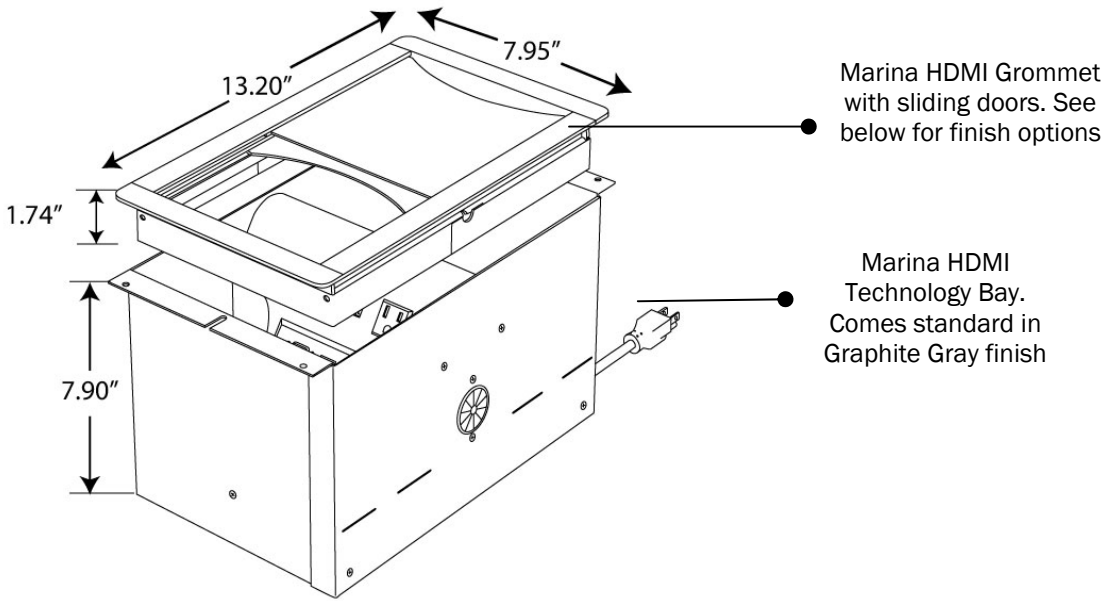

\*Telecom Plates sold separately, see page 100

MARINA HDMI MEETING TECHNOLOGY		
4 power, 4 2.1A USB charging ports, 4 HDMI Show Me cables, HDMI 4 position switch box, 2 plate cutouts*, 15' HDMI monitor cable, 108" cord		
PART NUMBER	GROMMET FINISH	LIST PRICE 1-10 Units
MAR-H-GW-108	Gloss White	\$6,207.50
MAR-H-S-108	Silver Pearl	\$6,207.50
MAR-H-B-108	Black	\$6,207.50
MAR-H-AL-108	Clear Brushed Aluminum	\$6,470.00
MAR-H-BA-108	Black Brushed Aluminum	\$6,470.00

MARINA HDMI TECHNOLOGY ADAPTER ACCESSORIES	DESCRIPTION	ADAPTERS PER PACK	LIST PRICE
ADPT-HDMI/VGA	HDMI to VGA adapter pack with audio support	2	\$475.00
ADPT-HDMI/DP	HDMI to DisplayPort adapter pack	2	\$147.50
ADPT-HDMI/MDP	HDMI to Mini DisplayPort & Thunderbolt adapter pack	2	\$130.00
ADPT-HDMI/30PIN	HDMI to Apple 30 pin adapter pack	2	\$912.50
ADPT-HDMI/LTN	HDMI to Apple Lightning adapter pack	2	\$725.00
ADPT-SAMPLEPK	Adapter sample pack. Includes one of each HDMI adapter	5	\$1,197.50

**TABLE REQUIREMENTS:**

Minimum Table Thickness..... .75"  
Table Cutout.....7.50" X 12.125"

ETL Listed

**Innovative Power + Data Solutions**

10 Mountain View Drive • Shelton, CT 06484 • P:800.521.3175 • F:203.924.6687 • www.electri-cable.com

# MARINA™ POWER DOCK

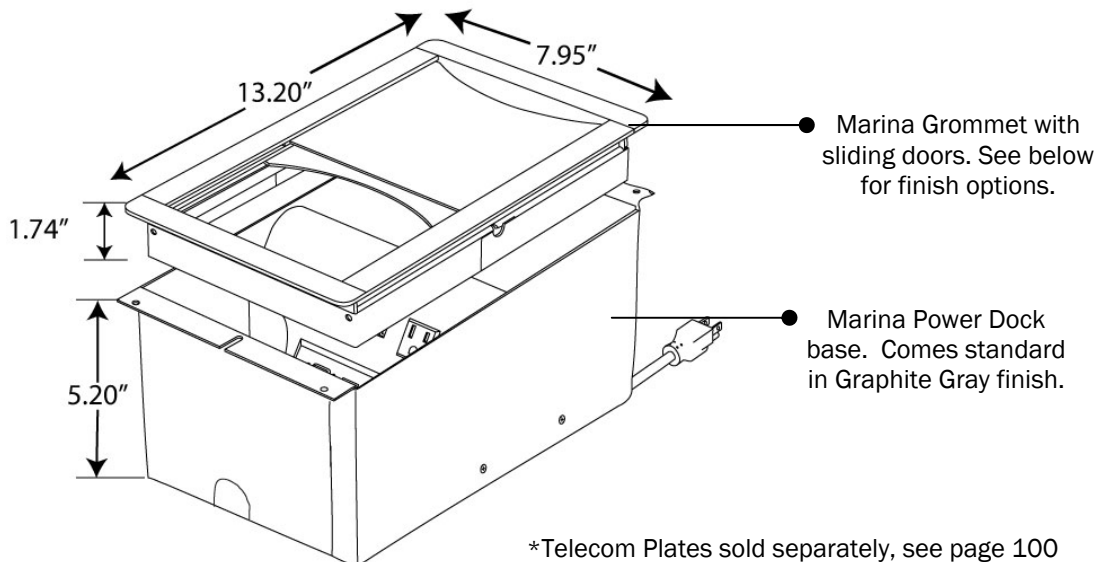

PART NUMBER	DESCRIPTION	GROMMET FINISH	LIST PRICE
MAR-PD-GW-108		Gloss White	\$1,955.00
MAR-PD-S-108	5 power including a convenience outlet on the underside of the unit , 4 2.1A USB charging ports, 2 telecom plate cutouts*, 108" cord	Silver Pearl	\$1,955.00
MAR-PD-B-108		Black	\$1,955.00
MAR-PD-AL-108		Clear Brushed Aluminum	\$2,217.50
MAR-PD-BA-108		Black Brushed Aluminum	\$2,217.50

ETL Listed

**PRODUCT INFORMATION:**

Table Thickness..... See Installation Instructions  
 Table Cutout.....7.50" X 12.125"



# OASIS A

Packed with Style, Power, and Data Capabilities.

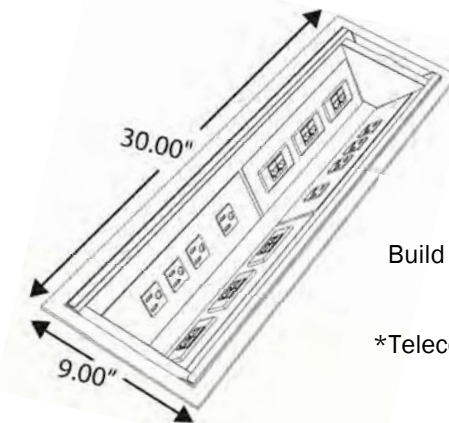

Build Your Own Configurations Available.

\*Telecom Plates sold separately, see page 100

OASIS A ALUMINUM PART NUMBER	CONFIGURATION	FINISH	LIST PRICE
OASIS A OASIS A BL	Oasis, 30" Trough with 8 Power Receptacles and 6 Telecom Plate Cutouts. Comes with 2 108" Standard Plugs.	Silver Pearl/ Clear Anodized Doors and Bezels  Black/ Black Anodized Doors and Bezels	\$4,310.00

OASIS A POWDER COAT PART NUMBER	CONFIGURATION	FINISH	LIST PRICE
OAS-A-PC-S OAS-A-PC-B	Oasis, 30" Trough with 8 Power Receptacles and 6 Telecom Plate Cutouts. Comes with 2 108" Standard Plugs.	Silver Pearl Powder Coat  Black Powder Coat	\$2,870.00

OASIS A DAISYLINK ALUMINUM PART NUMBER	CONFIGURATION	FINISH	LIST PRICE
OAS-A-4-1-S OAS-A-4-1-B	Oasis 30" Trough with 8 Power Receptacles and 6 Telecom Plate Cutouts. For DaisyChaining Multiple Units from 1 Power Infeed.	Silver Pearl/ Clear Anodized Doors and Bezels  Black/ Black Anodized Doors and Bezels	\$4,795.00

OASIS A DAISYLINK POWDER COAT PART NUMBER	CONFIGURATION	FINISH	LIST PRICE
OAS-A-PC-4-1-S OAS-A-PC-4-1-B	Oasis 30" Trough with 8 Power Receptacles and 6 Telecom Plate Cutouts. For DaisyChaining Multiple Units from 1 Power Infeed.	Silver Pearl Powder Coat  Black Powder Coat	\$3,450.00

OASIS OUTERPAN	FINISH	LIST PRICE
OASIS PAN	Black	\$142.50
OASIS PAN SLVR	Silver	

See page 38 for Starter Cable and Interconnecting Cable Options.

**\*Note:** This unit requires an undercut on the table. Please see installation instructions.

**PRODUCT INFORMATION:**

Unit Depth: .....4.05"  
 Maximum Table Thickness.....2.00"  
 Table Cutout.....8.25" x 29.12"

DaisyLink= CSA Certified  
 Oasis Power Inserts are UL Listed

**TABLE- TROUGHS**

# OASIS B

Packed with Style, Power, and Data Capabilities.

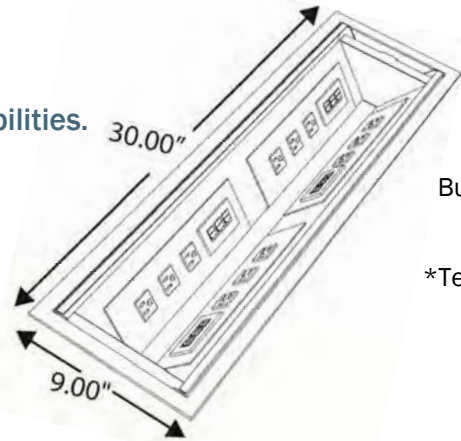

Build Your Own Configurations Available.

\*Telecom Plates sold separately, see page 100

OASIS B ALUMINUM PART NUMBER	CONFIGURATION	FINISH	LIST PRICE
OASIS B OASIS B BL	Oasis, 30" Trough with 12 Power Receptacles and 4 Telecom Plate Cutouts. Comes with 4 108" Standard Plugs.	Silver Pearl/ Clear Anodized Doors and Bezels	\$4,310.00
		Black/ Black Anodized Doors and Bezels	
OASIS B POWDER COAT PART NUMBER	CONFIGURATION	FINISH	LIST PRICE
OAS-B-PC-S OAS-B-PC-B	Oasis, 30" Trough with 12 Power Receptacles and 4 Telecom Plate Cutouts. Comes with 4 108" Standard Plugs.	Silver Pearl Powder Coat	\$2,870.00
		Black Powder Coat	
OASIS B DAISYLINK ALUMINUM PART NUMBER	CONFIGURATION	FINISH	LIST PRICE
OAS-B-4-1-S OAS-B-4-1-B	Oasis 30" Trough with 12 Power Receptacles and 4 Telecom Plate Cutouts. For DaisyChaining Multiple Units from 1 Power Infeed. DaisyLink Interconnecting and Hardwire Starter Cables Sold Separately, See page 38.	Silver Pearl/ Clear Anodized Doors and Bezels	\$4,795.00
		Black/ Black Anodized Doors and Bezels	
OASIS B DAISYLINK POWDER COAT PART NUMBER	CONFIGURATION	FINISH	LIST PRICE
OAS-B-PC-4-1-S OAS-B-PC-4-1-B	Oasis 30" Trough with 12 Power Receptacles and 4 Telecom Plate Cutouts. For DaisyChaining Multiple Units from 1 Power Infeed. DaisyLink Interconnecting and Hardwire Starter Cables Sold Separately, See page 38.	Silver Pearl Powder Coat	\$3,450.00
		Black Powder Coat	

See page 38 for Starter Cable and Interconnecting Cable Options.

OASIS OUTERPAN	FINISH	LIST PRICE
OASIS PAN	Black	\$142.50
OASIS PAN SLVR	Silver	

**\*Note:** This unit requires an undercut on the table. Please see installation instructions.

**PRODUCT INFORMATION:**

Unit Depth: .....4.05"  
 Maximum Table Thickness.....2.00"  
 Table Cutout.....8.25" x 29.12"

Oasis Power Inserts are UL Listed.  
 DaisyLink= CSA Certified

**Innovative Power + Data Solutions**

10 Mountain View Drive • Shelton, CT 06484 • P:800.521.3175 • F:203.924.6687 • www.electri-cable.com



# OASIS USB

Packed with Style, Power, and Data Capabilities.

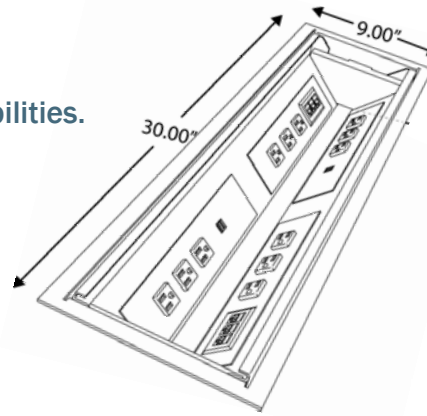

Build Your Own Configurations Available.

\*Telecom Plates sold separately, see page 100

OASIS U ALUMINUM PART NUMBER	CONFIGURATION	FINISH	LIST PRICE
OAS-U-AL-108 OAS-U-BA-108	Oasis, 30" Trough with 12 Power Receptacles, 4 USB Charging Ports, and 2 Telecom Plate Cutouts. Comes with 4 108" Standard Plugs.	Silver Pearl/ Clear Anodized Doors and Bezels  Black/ Black Anodized Doors and Bezels	\$4,655.00
OASIS U POWDER COAT PART NUMBER	CONFIGURATION	FINISH	LIST PRICE
OAS-U-PC-S-108 OAS-U-PC-B-108	Oasis, 30" Trough with 12 Power Receptacles, 4 USB Charging Ports, and 2 Telecom Plate Cutouts. Comes with 4 108" Standard Plugs.	Silver Pearl Powder Coat  Black Powder Coat	\$3,215.00
OASIS U DAISYLINK ALUMINUM PART NUMBER	CONFIGURATION	FINISH	LIST PRICE
OAS-U-4-1-AL OAS-U-4-1-BA	Oasis 30" Trough with 12 Power Receptacles, 4 USB Charging Ports, and 2 Telecom Plate Cutouts. For DaisyChaining Multiple Units from 1 Power Infeed. DaisyLink Interconnecting and Hardwire Starter Cables Sold Separately, See page 38.	Silver Pearl/ Clear Anodized Doors and Bezels  Black/ Black Anodized Doors and Bezels	\$5,135.00
OASIS U DAISYLINK POWDER COAT PART NUMBER	CONFIGURATION	FINISH	LIST PRICE
OAS-U-PC-4-1-S OAS-U-PC-4-1-B	Oasis 30" Trough with 12 Power Receptacles, 4 USB Charging Ports, and 2 Telecom Plate Cutouts. For DaisyChaining Multiple Units from 1 Power Infeed. DaisyLink Interconnecting and Hardwire Starter Cables Sold Separately, See page 38.	Silver Pearl Powder Coat  Black Powder Coat	\$3,692.50

See page 38 for Starter Cable and Interconnecting Cable Options.

OASIS OUTERPAN	FINISH	LIST PRICE
OASIS PAN OASIS PAN SLVR	Black Silver	\$142.50

**PRODUCT INFORMATION:**

Unit Depth: .....4.05"  
 Maximum Table Thickness.....2.00"  
 Table Cutout.....8.25" x 29.12"

**\*Note:** This unit requires an undercut on the table. Please see installation instructions.  
 Oasis Power Inserts are ETL Listed

Innovative Power + Data Solutions

10 Mountain View Drive • Shelton, CT 06484 • P:800.521.3175 • F:203.924.6687 • www.electri-cable.com

# OASIS UT SERIES

The Oasis Family of Decorative Undertable Solutions.

\*Telecom Plates sold separately, see page 100

**PART NUMBER KEY:**

- OASIS UT A-** 8 Power, 6 Telecom Plate Cutouts.
- OASIS UT B-** 12 Power, 4 Telecom Plate Cutouts.
- OASIS UT U-** 12 Power, 4 USB Charging Ports, and 2 Telecom Plate Cutouts.

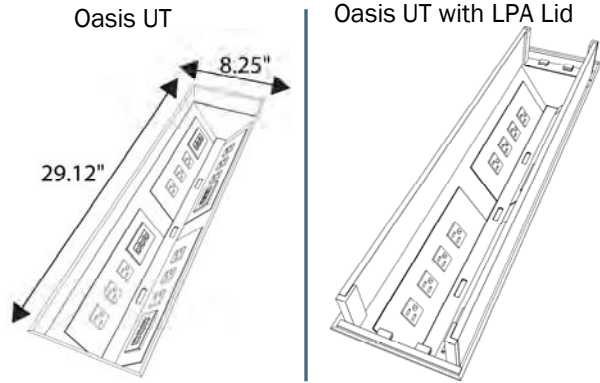

OASIS UT A	PART NUMBER	CONFIGURATION	FINISH	LIST PRICE
	OASIS UT A OASIS UT A BL	Oasis Undertable with 8 Power and 6 Telecom Plate Cutouts. Comes with 2 108" Standard Plugs. UL Listed.	Silver Black	\$1,717.50

OASIS UT B	PART NUMBER	CONFIGURATION	FINISH	LIST PRICE
	OASIS UT B OASIS UT B BL	Oasis Undertable with 12 Power and 4 Telecom Plate Cutouts. Comes with 4 108" Standard Plugs. UL Listed.	Silver Black	\$1,717.50

OASIS UT U	PART NUMBER	CONFIGURATION	FINISH	LIST PRICE
	OAS-UT-U-S-108 OAS-UT-U-B-108	Oasis Undertable with 12 Power, 4 USB Charging Ports, and 2 Telecom Plate Cutouts. Comes with 4 108" Standard Plugs. ETL Listed.	Silver Black	\$1,902.50

OASIS UT ACCESSORIES	PART NUMBER	DESCRIPTION	FINISH	LIST PRICE
	OASIS UT LPA	Trim Pivot Kit for Oasis and Oasis Mini Undertable Lids for Oasis	Brushed Aluminum	\$480.00
	OASIS UT LG2		Frosted Glass	\$455.00

OASIS OUTERPAN	FINISH	LIST PRICE
OASIS PAN	Black	\$142.50
OASIS PAN SLVR	Silver	

**TABLE REQUIREMENTS:**

- Unit Depth .....3.89"
- Oasis Table Cutout.....29.12" x 8.25"
- Minimum Table Thickness: 0.75" When Using the Trim Pivot Kit

# OASIS - MINI A

Miniature in Size, Large in Style.

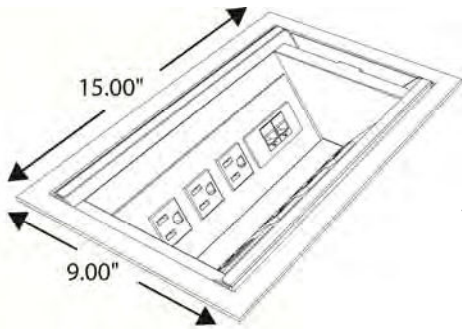

Build Your Own Configurations Available.

\*Telecom Plates sold separately, see page 100

OASIS-MINI A ALUMINUM PART NUMBER	CONFIGURATION	FINISH	LIST PRICE
OASIS-MINI A OASIS-MINI A BL	Oasis, 15" Trough with 6 Power Receptacles and 2 Telecom Plate Cutouts. Comes with 2 108" Standard Plugs.	Silver Pearl/ Clear Anodized Doors and Bezels  Black/ Black Anodized Doors and Bezels	\$2,390.00
OASIS-MINI A POWDER COAT PART NUMBER	CONFIGURATION	FINISH	LIST PRICE
OAM-A-PC-S OAM-A-PC-B	Oasis, 15" Trough with 6 Power Receptacles and 2 Telecom Plate Cutouts. Comes with 2 108" Standard Plugs.	Silver Pearl Powder Coat  Black Powder Coat	\$1,670.00
OASIS-MINI A DAISYLINK ALUMINUM PART NUMBER	CONFIGURATION	FINISH	LIST PRICE
OAM-A-4-1-S OAM-A-4-1-B	Oasis 15" Trough with 6 Power Receptacles and 2 Telecom Plate Cutouts. For DaisyChaining Multiple Units from 1 Power Infeed. DaisyLink Interconnecting and Hardwire Starter Cables Sold Separately.	Silver Pearl/ Clear Anodized Doors and Bezels  Black/ Black Anodized Doors and Bezels	\$2,682.50
OASIS-MINI A DAISYLINK POWDER COAT PART NUMBER	CONFIGURATION	FINISH	LIST PRICE
OAM-A-PC-4-1-S OAM-A-PC-4-1-B	Oasis 15" Trough with 6 Power Receptacles and 2 Telecom Plate Cutouts. For DaisyChaining Multiple Units from 1 Power Infeed. DaisyLink Interconnecting and Hardwire Starter Cables Sold Separately.	Silver Pearl Powder Coat  Black Powder Coat	\$1,910.00

See page 38 for Starter Cable and Interconnecting Cable Options.

OASIS MINI OUTERPAN	FINISH	LIST PRICE
OASIS-MINI PANB	Black	\$120.00
OASIS-MINI PANS	Silver	

\*Note: This unit requires an undercut on the table. Please see installation instructions.

**TABLE REQUIREMENTS:**

Unit Depth: .....4.05"  
 Maximum Table Thickness.....2.00"  
 Table Cutout.....8.25" x 14.12"

DaisyLink= CSA Certified  
 Oasis Power Inserts are UL Listed.

Innovative Power + Data Solutions

10 Mountain View Drive • Shelton, CT 06484 • P:800.521.3175 • F:203.924.6687 • www.electri-cable.com

# OASIS - MINI B

Miniature in Size, Large in Style.

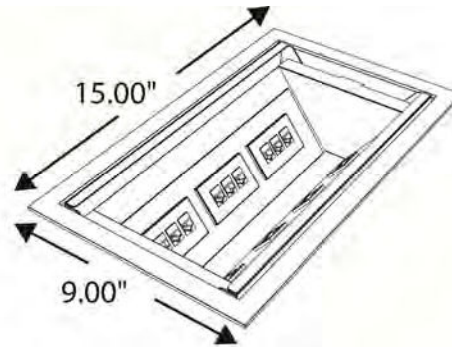

Build Your Own Configurations Available.

\*Telecom Plates sold separately, see page 100

OASIS-MINI B ALUMINUM PART NUMBER	CONFIGURATION	FINISH	LIST PRICE
OASIS-MINI B* OASIS-MINI B BL	Oasis, 15" Trough with 4 Power Receptacles and 3 Telecom Plate Cutouts. Comes with 1 108" Standard Plugs.	Silver Pearl/ Clear Anodized Doors and Bezels  Black/ Black Anodized Doors and Bezels	\$2,390.00

OASIS-MINI B POWDER COAT PART NUMBER	CONFIGURATION	FINISH	LIST PRICE
OAM-B-PC-S OAM-B-PC-B	Oasis, 15" Trough with 4 Power Receptacles and 3 Telecom Plate Cutouts. Comes with 1 108" Standard Plugs.	Silver Pearl Powder Coat  Black Powder Coat	\$1,670.00

OASIS-MINI B DAISYLINK ALUMINUM PART NUMBER	CONFIGURATION	FINISH	LIST PRICE
OAM-B-4-1-S OAM-B-4-1-B	Oasis 15" Trough with 4 Power Receptacles and 3 Telecom Plate Cutouts. For DaisyChaining Multiple Units from 1 Power Infeed. DaisyLink Interconnecting and Hardware Starter Cables Sold Separately.	Silver Pearl/ Clear Anodized Doors and Bezels  Black/ Black Anodized Doors and Bezels	\$2,682.50

OASIS-MINI B DAISYLINK POWDER COAT PART NUMBER	CONFIGURATION	FINISH	LIST PRICE
OAM-B-PC-4-1-S OAM-B-PC-4-1-B	Oasis 15" Trough with 4 Power Receptacles and 3 Telecom Plate Cutouts. For DaisyChaining Multiple Units from 1 Power Infeed. DaisyLink Interconnecting and Hardware Starter Cables Sold Separately.	Silver Pearl Powder Coat  Black Powder Coat	\$1,910.00

See page 38 for Starter Cable and Interconnecting Cable Options.

OASIS MINI OUTERPAN	FINISH	LIST PRICE
OASIS-MINI PAN	Black	\$120.00
OASIS-MINI PANS	Silver	

**\*Note:** This unit requires an undercut on the table. Please see installation instructions.

**TABLE REQUIREMENTS:**

Unit Depth: .....4.05"  
 Maximum Table Thickness.....2.00"  
 Table Cutout.....8.25" x 14.12"

DaisyLink= CSA Certified  
 Oasis Power Inserts are UL Listed.

**TABLE- TROUGHS**

# OASIS - MINI USB

Miniature in Size, Large in Style.

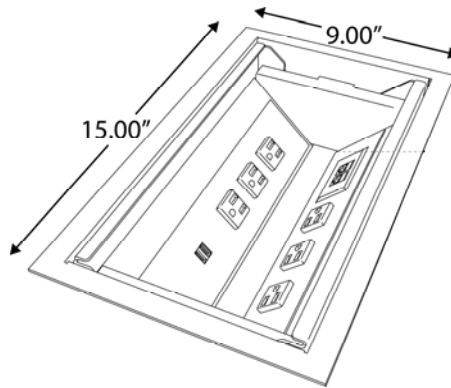

Build Your Own Configurations Available.

\*Telecom Plates sold separately, see page 100

OASIS-MINI U ALUMINUM PART NUMBER	CONFIGURATION	FINISH	LIST PRICE
OAM-U-AL-108	Oasis, 15" Trough with 6 Power Receptacles, 2 USB Charging Ports, and 1 Telecom Plate Cutout. Comes with 2 108" Standard Plugs.	Silver Pearl/ Clear Anodized Doors and Bezels	\$2,557.50
OAM-U-BA-108		Black/ Black Anodized Doors and Bezels	

OASIS-MINI U POWDER COAT PART NUMBER	CONFIGURATION	FINISH	LIST PRICE
OAM-U-PC-S-108	Oasis, 15" Trough with 6 Power Receptacles, 2 USB Charging Ports, and 1 Telecom Plate Cutout. Comes with 2 108" Standard Plugs.	Silver Pearl Powder Coat	\$1,832.50
OAM-U-PC-B-108		Black Powder Coat	

OASIS-MINI U DAISYLINK ALUMINUM PART NUMBER	CONFIGURATION	FINISH	LIST PRICE
OAM-U-4-1-AL	Oasis 15" Trough with 6 Power Receptacles, 2 USB Charging Ports, and 1 Telecom Plate Cutout. For DaisyChaining Multiple Units from 1 Power Infeed.	Silver Pearl/ Clear Anodized Doors and Bezels	\$2,800.00
OAM-U-4-1-BA		Black/ Black Anodized Doors and Bezels	

OASIS-MINI U DAISYLINK POWDER COAT PART NUMBER	CONFIGURATION	FINISH	LIST PRICE
OAM-U-PC-4-1-S	Oasis 15" Trough with 6 Power Receptacles, 2 USB Charging Ports, and 1 Telecom Plate Cutout. For DaisyChaining Multiple Units from 1 Power Infeed.	Silver Pearl Powder Coat	\$2,080.00
OAM-U-PC-4-1-B		Black Powder Coat	

See page 38 for Starter Cable and Interconnecting Cable Options.

OASIS MINI OUTERPAN	FINISH	LIST PRICE
OASIS-MINI PAN	Black	\$120.00
OASIS-MINI PANS	Silver	

**\*Note:** This unit requires an undercut on the table. Please see installation instructions.

**TABLE REQUIREMENTS:**

Unit Depth: .....4.05"  
 Maximum Table Thickness.....2.00"  
 Table Cutout.....8.25" x 14.12"

Oasis Power Inserts are ETL Listed

**Innovative Power + Data Solutions**

10 Mountain View Drive • Shelton, CT 06484 • P:800.521.3175 • F:203.924.6687 • www.electri-cable.com

# OASIS- MINI UT SERIES

The Oasis Family of Decorative Undertable Solutions.

\*Telecom Plates sold separately, see page 100

**PART NUMBER KEY:**

**OASIS-MINI UTA**– 6 Power, 2 Telecom Plate Cutouts.

**OASIS-MINI UTB**– 4 Power, 3 Telecom Plate Cutouts.

**OASIS-MINI UTU**– 6 Power, 2 USB, 1 Telecom Plate Cutout.

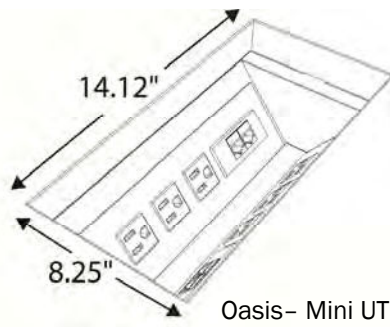

Oasis- Mini UT



Oasis- Mini UT with LPA Lid

OASIS- MINI UT A	PART NUMBER	CONFIGURATION	FINISH	LIST PRICE
	OASIS-MINI UT A OASIS-MINUT ABL	Oasis-Mini Undertable with 6 Power and 2 Telecom Plate Cutouts. Comes with 2 108" Standard Plugs. UL Listed.	Silver Black	\$842.50

OASIS- MINI UT B	PART NUMBER	CONFIGURATION	FINISH	LIST PRICE
	OASIS-MINI UT B OASIS-MINUT BBL	Oasis-Mini Undertable with 4 Power and 3 Telecom Plate Cutouts. Comes with 1 108" Standard Plugs. UL Listed.	Silver Black	\$842.50

OASIS- MINI UT U	PART NUMBER	CONFIGURATION	FINISH	LIST PRICE
	OAM-UT-U-S-108 OAM-UT-U-B-108	Oasis Mini Undertable with 6 Power, 2 USB Charging Ports, and 1 Telecom Plate Cutout. Comes with 2 108" Standard Plugs. ETL Listed.	Silver Black	\$1,010.00

OASIS-MINI UT ACCESSORIES	PART NUMBER	DESCRIPTION	FINISH	LIST PRICE
	OASIS UT LPA	Trim Pivot Kit for Oasis and Oasis Mini Undertable Lids for Oasis	Brushed Aluminum	\$480.00
	OASISMINI UTLG2		Frosted Glass	\$360.00

OASIS OUTERPAN	FINISH	LIST PRICE
OASIS-MINI PAN	Black	\$120.00
OASIS-MINI PANS	Silver	

**TABLE REQUIREMENTS:**

Oasis Mini Table Cutout.....14.12" x 8.25"

Minimum Table Thickness: 0.75" When Using the Trim Pivot Kit

Innovative Power + Data Solutions

10 Mountain View Drive • Shelton, CT 06484 • P:800.521.3175 • F:203.924.6687 • www.electri-cable.com



# POPPY

FAST WIRELESS CHARGING MADE SIMPLE.

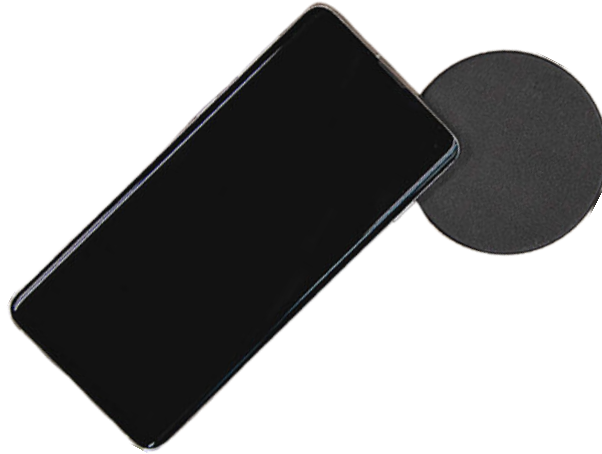

PART NUMBER	CONFIGURATION	FINISH	LIST PRICE
POP-B-72	10-Watt fast-charging wireless grommet. Includes grommet bracket, screws, and AC Adapter	Black (Faux Leather)	\$102.50

Please Note: Poppy works with Qi technology; Capable of charging Qi 5W, iPhones 7.5W fast charging, and Samsung 10W fast charging devices

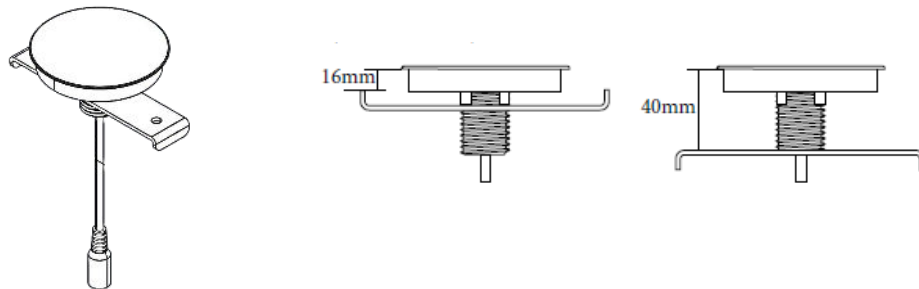

**PRODUCT INFORMATION:**

Charging Power.....1.8A/9V Input; 2A/9V Output AC Adapter  
 Fits Surface Thicknesses:.....0.63" - 1.57"  
 Table Cutout.....2.44"-2.55" Diameter

Innovative Power + Data Solutions

10 Mountain View Drive • Shelton, CT 06484 • P:800.521.3175 • F:203.924.6687 • www.electri-cable.com





# POWER ISLAND—DAISYLINK® SYSTEM

Power that moves with you.

## DaisyLink® Quick Kits: Step 1- Select Your Box

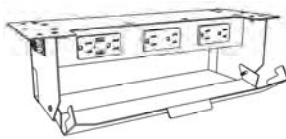
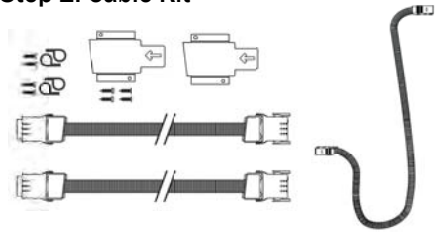
DaisyLink® Quick Kits Require The Following Selections:

<p><b>Step 1: Power Box</b></p> 	<p><b>Step 2: Cable Kit</b></p> 	<p><b>Step 3: Power Infeed</b></p> 
---	--	--

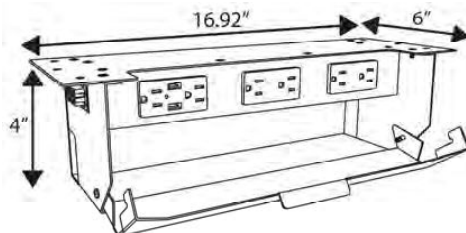

**Power Island Power Boxes Include:**

- 6 Power Receptacles (see circuit allocation below)
- 2 3.6 amp USB
- 1 Telecom Plate Knockout
- Mounting Hardware

Replace “S” for Silver in Part Number with:  
B for Black  
GW for Gloss White

PART NUMBER	RECEPTACLES PER CIRCUIT						LIST PRICE
	Circuit 1	Circuit 2	Circuit 3	Circuit 4	Circuit 3 IG	Circuit 4 IG	
PI-84-11-U-KO-S	6						\$537.50
PI-84-12-U-KO-S	3	3					
PI-84-13-U-KO-S	3		3				
PI-84-14-U-KO-S	3			3			
PI-84-23-U-KO-S		3	3				
PI-84-24-U-KO-S		3		3			
PI-84-34-U-KO-S			3	3			
PI-84-3IG1-UKOS	4				2		
PI-84-4IG1-UKOS	4					2	
PI-84-3IG2-UKOS		4			2		
PI-84-4IG2-UKOS		4				2	

PART NUMBER	RECEPTACLES PER CIRCUIT (CONTROLLED CIRCUIT POWER)						LIST PRICE
	Circuit 1	Circuit 1 Controlled	Circuit 2	Circuit 2 Controlled	Circuit 3	Circuit 4	
PI-84-21CC-UKOS		3	3				\$550.00
PI-84-31CC-UKOS		3			3		
PI-84-41CC-UKOS		3				3	
PI-84-12CC-UKOS	3			3			
PI-84-32CC-UKOS				3	3		
PI-84-42CC-UKOS				3		3	

**PRODUCT INFORMATION:**

Table Thickness Minimum..... 1” with supplied mounting hardware  
-Note DaisyLink Quick Kits require Power Box, Cable Kit, and Power Infeed all ordered separately

ETL Certified

Innovative Power + Data Solutions

10 Mountain View Drive • Shelton, CT 06484 • P:800.521.3175 • F:203.924.6687 • www.electri-cable.com

# POWER ISLAND—DAISYLINK® SYSTEM (CONT.)

Power that moves with you.

## DaisyLink® Quick Kits: Step 2 & 3- Select Your Cable Kit and Power Infeed

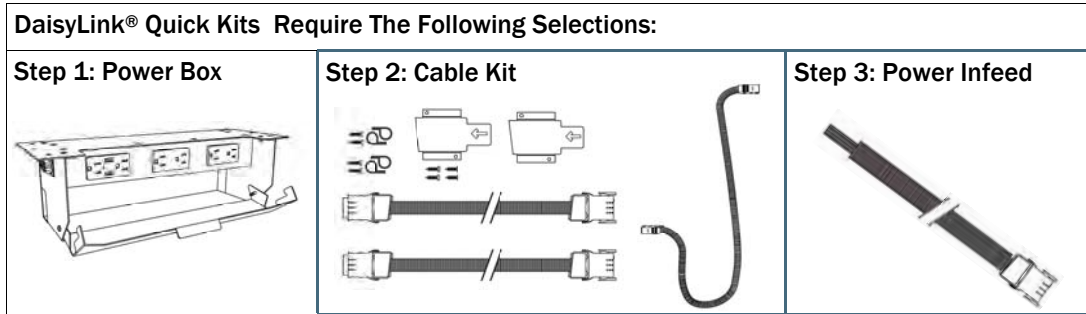

Power Island Cable Kits are based on table length and include:

- 2 DaisyLink® Female/Male Cables
- 2 Mounting Brackets & Mounting Screws
- 2 U-Clamps
- 1 Loop Cable

### Step 2: Select Your Cable Kit

CABLE KITS	PART NUMBER	DESCRIPTION	LIST PRICE
	PI-84DL-42K	42" Table Kit: 2 84DL FM-14" cables, 2 Mounting Brackets, Mounting Screws, 2 U Clamps, 42" Loop Cable with Black Mesh	\$387.50
	PI-84DL-48K	48" Table Kit: 2 84DL FM-17" cables, 2 Mounting Brackets, Mounting Screws, 2 U Clamps, 42" Loop Cable with Black Mesh	
	PI-84DL-54K	54" Table Kit: 2 84DL FM-20" cables, 2 Mounting Brackets, Mounting Screws, 2 U Clamps, 42" Loop Cable with Black Mesh	
	PI-84DL-60K	60" Table Kit: 2 84DL FM-23" cables, 2 Mounting Brackets, Mounting Screws, 2 U Clamps, 42" Loop Cable with Black Mesh	
	PI-84DL-66K	66" Table Kit: 2 84DL FM-26" cables, 2 Mounting Brackets, Mounting Screws, 2 U Clamps, 42" Loop Cable with Black Mesh	
	PI-84DL-72K	72" Table Kit: 2 84DL FM-29" cables, 2 Mounting Brackets, Mounting Screws, 2 U Clamps, 42" Loop Cable with Black Mesh	
	PI-84DL-84K	84" Table Kit: 2 84DL FM-35" cables, 2 Mounting Brackets, Mounting Screws, 2 U Clamps, 42" Loop Cable with Black Mesh	

### Step 3: Select Your Power Infeed

POWER INFEEED STARTERS	PART NUMBER	DESCRIPTION	LIST PRICE
	84DL SB2-XX"B	DaisyLink 8 Wire, 4 Circuit Hardwire Power Infeed with Black Mesh	\$66.25 + \$2.05 per inch
	84DL 20AP1-72"B	DaisyLink 8 Wire, 4 Circuit 20 Amp Single Circuit Starter, 48" cable 24" corded plug, Black Mesh	\$287.50

#### PRODUCT INFORMATION:

-Note DaisyLink® Quick Kits require Power Box, Cable Kit, and Power Infeed all ordered separately  
XX Represents length of cable

ETL Certified

Innovative Power + Data Solutions

10 Mountain View Drive • Shelton, CT 06484 • P:800.521.3175 • F:203.924.6687 • www.electri-cable.com

# POWER SLIP—DAISYLINK® SYSTEM

Power that moves with you.

## DaisyLink® Quick Kits: Step 1- Select Your Power Unit

DaisyLink® Quick Kits Require The Following Selection:

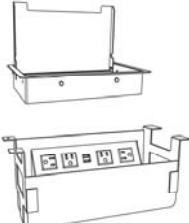
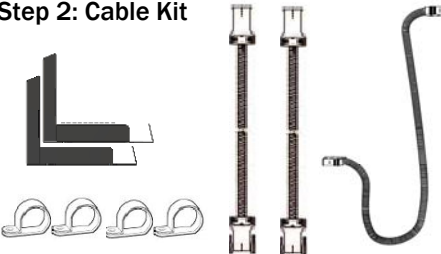
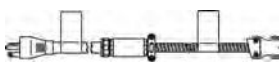
<p><b>Step 1: Power Unit</b></p> 	<p><b>Step 2: Cable Kit</b></p> 	<p><b>Step 3: Power Infeed</b></p> 
--	--	--

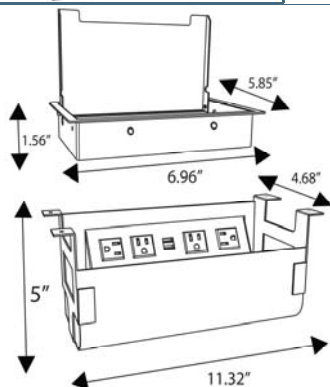

**Power Slip Power Units Include:**

- 2 or 4 Power Receptacles
- 2 2.1 amp USB
- 2 Telecom Plate Knockouts (Telecom Plates purchased separately—see page 100)
- Grommet Mounting Hardware

Part Number		LIST PRICE
PS-41-2U-S	2 Power, 2 USB Circuit 1 Power Unit and Silver Grommet	\$537.50
PS-41-2U-B	2 Power, 2 USB Circuit 1 Power Unit and Black Grommet	
PS-41-2U-GW	2 Power, 2 USB Circuit 1 Power Unit and Gloss White Grommet	
PS-42-2U-S	2 Power, 2 USB Circuit 2 Power Unit and Silver Grommet	
PS-42-2U-B	2 Power, 2 USB Circuit 2 Power Unit and Black Grommet	
PS-42-2U-GW	2 Power, 2 USB Circuit 2 Power Unit and Gloss White Grommet	
PS-41-4U-S	4 Power, 2 USB Circuit 1 Power Unit and Silver Grommet	\$562.50
PS-41-4U-B	4 Power, 2 USB Circuit 1 Power Unit and Black Grommet	
PS-41-4U-GW	4 Power, 2 USB Circuit 1 Power Unit and Gloss White Grommet	
PS-42-4U-S	4 Power, 2 USB Circuit 2 Power Unit and Silver Grommet	
PS-42-4U-B	4 Power, 2 USB Circuit 2 Power Unit and Black Grommet	
PS-42-4U-GW	4 Power, 2 USB Circuit 2 Power Unit and Gloss White Grommet	

**PRODUCT INFORMATION:**

Standard Table Thickness..... .75"-1.5"  
 Required Cutout..... See Installation Instructions  
 Note DaisyLink® Quick Kits require Power Unit, Cable Kit, and Power Infeed all ordered separately

ETL Certified

Innovative Power + Data Solutions



10 Mountain View Drive • Shelton, CT 06484 • P:800.521.3175 • F:203.924.6687 • www.electri-cable.com

# POWER SLIP—DAISYLINK® SYSTEM — (CONT.)

Power that moves with you.

## DaisyLink® Quick Kits: Steps 2 & 3- Select Your Cable Kit & Power Infeed

DaisyLink® Quick Kits Require The Following Selection:

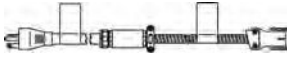
<b>Step 1: Power Unit</b> 	<b>Step 2: Cable Kit</b> 	<b>Step 3: Power Infeed</b> 
--	--	--



Power Slip Cable Kits are based on table length and include:

- 2 DaisyLink® Female Male Cables
- 2 Mounting Brackets & Mounting Screws
- 2 Clamps
- 1 Loop Cable

### Step 2: Select Your Cable Kit

CABLE KITS	PART NUMBER	DESCRIPTION	LIST PRICE
	HAT42-CAB-42K	42" Table Kit: 2 42FM 12" Cables, 2 Mounting Brackets, Mounting Screws, 2 Clamps, 48" Loop Cable with Black Mesh	\$357.50
	HAT42-CAB-48K	48" Table Kit: 2 42FM 13" Cables, 2 Mounting Brackets, Mounting Screws, 2 Clamps, 48" Loop Cable with Black Mesh	
	HAT42-CAB-54K	54" Table Kit: 2 42FM 16" Cables, 2 Mounting Brackets, Mounting Screws, 2 Clamps, 48" Loop Cable with Black Mesh	
	HAT42-CAB-60K	60" Table Kit: 2 42FM 19" Cables, 2 Mounting Brackets, Mounting Screws, 2 Clamps, 48" Loop Cable with Black Mesh	
	HAT42-CAB-66K	66" Table Kit: 2 42FM 22" Cables, 2 Mounting Brackets, Mounting Screws, 2 Clamps, 48" Loop Cable with Black Mesh	
	HAT42-CAB-72K	72" Table Kit: 2 42FM 25" Cables, 2 Mounting Brackets, Mounting Screws, 2 Clamps, 48" Loop Cable with Black Mesh	
	HAT42-CAB-84K	84" Table Kit: 2 42FM 31" Cables, 2 Mounting Brackets, Mounting Screws, 2 Clamps, 48" Loop Cable with Black Mesh	

### Step 3: Select Your Starter Infeed

POWER INFEEED OPTIONS	PART NUMBER	DESCRIPTION	LIST PRICE
	42SB2- LENGTH-B	Multi-Circuit Hardwire Power Infeed with black mesh	\$57.50 + \$.150 per inch
	42 QD INSERT	Insert for Floor Box and Wall Outlet Applications. Fits Standard Decora® Opening.	\$115.00
	4220AP1-72-B	Single Circuit 20 Amp Power Infeed with 72" Molded Plug with Black Mesh	\$227.50

**PRODUCT INFORMATION:**

Note DaisyLink® Quick Kits require Power Unit, Cable Kit, and Power Infeed all ordered separately

ETL Certified

Innovative Power + Data Solutions

10 Mountain View Drive • Shelton, CT 06484 • P:800.521.3175 • F:203.924.6687 • www.electri-cable.com

# POWER STRIPS

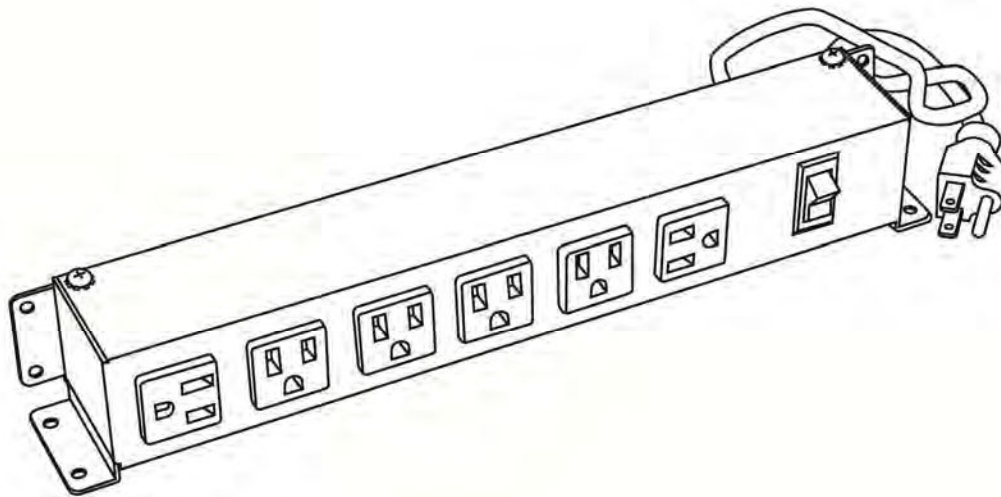

PART NUMBER	CONFIGURATION	FINISH	LIST PRICE
PS4-B-108 PS4-S-108	Power Strip, 4 power, Circuit Breaker ON/OFF switch, 108" Cord	Black Silver Pearl	\$147.50
PS6-B-108 PS6-S-108	Power Strip, 6 power, Circuit Breaker ON/OFF switch, 108" Cord	Black Silver Pearl	\$157.50
PS8-B-108 PS8-S-108	Power Strip, 8 power, Circuit Breaker ON/OFF switch, 108" Cord	Black Silver Pearl	\$187.50

REEF™

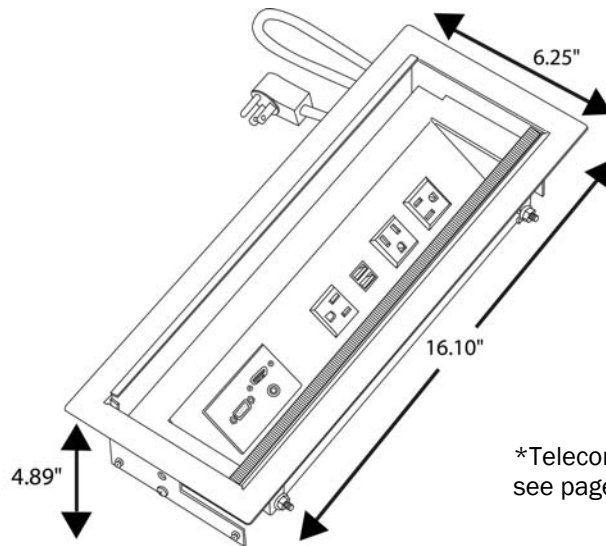

\*Telecom Plates sold separately, see page 100

REEF CORDED			
PART NUMBER	DESCRIPTION	FINISH	LIST PRICE
REF-31U-S-108 REF-31U-B-108 REF-31U-GW-108 REF-31U-AL-108	Reef, 3 Power, 1 Convenience, 2 2.1 AMP USB, 1 Data Plate Knock Out, 2 RJ45 Knock Outs, 108" Power Cord	Silver Pearl Black Gloss White Clear Brushed Aluminum	\$1,022.50 \$1,022.50 \$1,022.50 \$1,442.50
REF-4U-S-108 REF-4U-B-108 REF-4U-GW-108 REF-4U-AL-108	Reef, 4 Power, 2 2.1 AMP USB, 1 Data Plate Knock Out, 2 RJ45 Knock Outs, 108" Power Cord	Silver Pearl Black Gloss White Clear Brushed Aluminum	\$1,022.50 \$1,022.50 \$1,022.50 \$1,442.50

REEF DAISYLINK			
PART NUMBER	DESCRIPTION	FINISH	LIST PRICE
REF-4-1-3U-S REF-4-1-3U-B REF-4-1-3U-GW REF-4-1-3U-AL	Reef, 3 Power, 2 2.1 AMP USB, 1 Data Plate Knock Out, 2 RJ45 Knock Outs, DaisyLink	Silver Pearl Black Gloss White Clear Brushed Aluminum	\$1,337.50 \$1,337.50 \$1,337.50 \$1,785.00
REF-4-1-4U-S REF-4-1-4U-B REF-4-1-4U-GW REF-4-1-4U-AL	Reef, 4 Power, 2 2.1 AMP USB, 1 Data Plate Knock Out, 2 RJ45 Knock Outs, DaisyLink	Silver Pearl Black Gloss White Clear Brushed Aluminum	\$1,337.50 \$1,337.50 \$1,337.50 \$1,785.00

See page 38 for Starter Cable and Interconnecting Cable For DaisyLink: Change the "1" to a "2" to Specify Circuit 2.

Hardwired Units Available

**\*Note:** This unit requires an undercut on the table. Please see installation instructions.

**PRODUCT INFORMATION:**

ETL Listed

Unit Depth: .....4.89"  
Maximum Table Thickness.....2"  
Table Cutout.....5.38" X 15.25"



Innovative Power + Data Solutions

10 Mountain View Drive • Shelton, CT 06484 • P:800.521.3175 • F:203.924.6687 • www.electri-cable.com

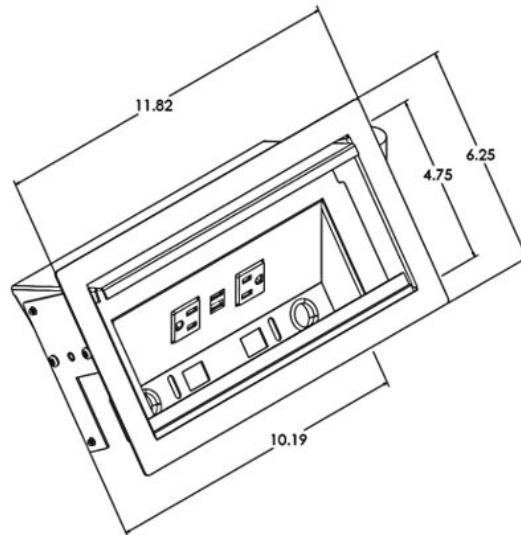

# REEF MINI

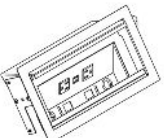
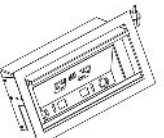

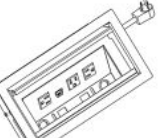
REEF MINI CORDED				
	PART NUMBER	DESCRIPTION	FINISH	LIST PRICE
	REF-SM-2U-S-108 REF-SM-2U-B-108 REF-SM-2U-GW108 REF-SM-2U-AL108	2 Power, 2 USB, 2 Data Knockouts, 108" Cord	Silver Pearl Black Gloss White Brushed Aluminum	\$750.00 \$750.00 \$750.00 \$1170.00
	REF-SM-2UACS108 REF-SM2UACB108 REF-SM2UACGW108 REF-SM2UACAL108	2 Power, 1 USB-A, 1 USB-C, 2 Data Knockouts, 108" Power Cord	Silver Pearl Black Gloss White Brushed Aluminum	\$787.50 \$787.50 \$787.50 \$1207.50
	REF-SM-31U-S-108 REF-SM-31U-B-108 REF-SM-31UGW108 REF-SM-31UAL108	3 Power, 2 USB, 1 Convenience Outlet, 2 Data Knockouts, 108" Power Cord	Silver Pearl Black Gloss White Brushed Aluminum	\$875.00 \$875.00 \$875.00 \$1295.00
	REF-SM31UACS108 REF-SM31UACB108 REFSM31UACGW108 REFSM31UACAL108	3 Power, 1 USB-A, 1 USB-C, 1 Convenience Outlet, 2 Data Knockouts, 108" Power Cord	Silver Pearl Black Gloss White Brushed Aluminum	\$912.50 \$912.50 \$912.50 \$1332.50

**PRODUCT INFORMATION:**

**\*Note:** This unit requires an undercut on the table. Please see installation instructions.

Unit Depth.....4.89"

ETL Listed

Maximum Table Thickness.....1.00" - 2.00"

Table Cutout.....5.38" x 10.88"

**Innovative Power + Data Solutions**

10 Mountain View Drive • Shelton, CT 06484 • P:800.521.3175 • F:203.924.6687 • www.electri-cable.com



# RETRO SERIES CORDED—

## COVE™ LG & COVE™ RJ & RJ2

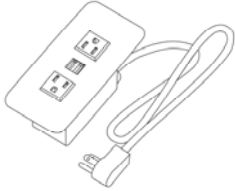
COVE LG	PART NUMBER	FINISH	LIST PRICE
	COV-LG-2U-GW108	Gloss White	\$315.00
	COV-LG-2U-S-108	Silver Pearl	\$315.00
	COV-LG-2U-B-108	Black	\$315.00
	COV-LG-2U-AL108	Clear Brushed Aluminum	\$382.50

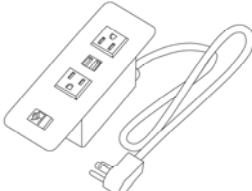
COVE RJ	PART NUMBER	FINISH	LIST PRICE
	COV-RJ-2UGW108	Gloss White	\$315.00
	COV-RJ-2U-S-108	Silver Pearl	\$315.00
	COV-RJ-2U-B-108	Black	\$315.00
	COV-RJ-2UAL108	Clear Brushed Aluminum	\$382.50

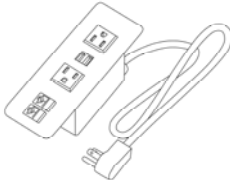
COVE RJ2	PART NUMBER	FINISH	LIST PRICE
	COV-RJ2-2UGW108	Gloss White	\$315.00
	COV-RJ2-2U-S108	Silver Pearl	\$315.00
	COV-RJ2-2U-B108	Black	\$315.00
	COV-RJ2-2UAL108	Clear Brushed Aluminum	\$382.50

DATA OPTIONS SOLD SEPARATELY Can be inserted into the Data Knock Outs in the Units to Upgrade Communication Capabilities		
PART NUMBER	DESCRIPTION	LIST PRICE
RJ45-B	RJ45 Cat 6 Data Jack	\$57.50
HDMI-KEY-B	HDMI F/F Keystone Jack-Black	\$61.25
USB-KEY-20AA-B	USB 2.0 Keystone Type A/A—Black	\$133.50
USB-KEY-20AA-W	USB 2.0 Keystone Type A/A—White	\$62.25
*Used for transferring data not charging		

**TABLE REQUIREMENTS:**

**COVE LG**

Table Thickness..... .25" x 1.50"

Table Cutout.....2.5" x 6.0"

**COVE RJ & RJ2**

Table Thickness..... .25" x 1.50"

Table Cutout.....2.0" x 6.75"

108" Cord Standard

CORD LENGTH OPTION FEES	
COVE STANDARD CORD LENGTH = 108"	
36"	+ \$13.75
72"	+ \$13.75
144"	+ \$18.75
180"	+ \$25.00
240"	+ \$37.50

**NOTE:** One Time \$295.00 Custom Cord Length Fee for all non-standard cord length

ETL Listed

# RETRO SERIES—DAISYLINK™ SYSTEM

## COVE™ LG & COVE™ RJ & RJ2

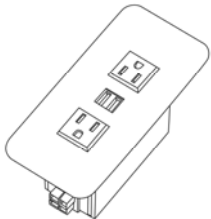
COVE LG DAISYLINK	PART NUMBER	FINISH	LIST PRICE
	COV-LG-2U-41-GW	Gloss White	\$315.00
	COV-LG-2U-4-1-S	Silver Pearl	\$315.00
	COV-LG-2U-4-1-B	Black	\$315.00
	COV-LG-2U-41-AL	Clear Brushed Aluminum	\$382.50

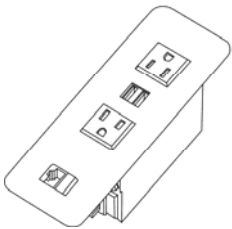
COVE RJ DAISYLINK	PART NUMBER	FINISH	LIST PRICE
	COV-RJ-2U-41-GW	Gloss White	\$315.00
	COV-RJ-2U-4-1-S	Silver Pearl	\$315.00
	COV-RJ-2U-4-1-B	Black	\$315.00
	COV-RJ-2U-41-AL	Clear Brushed Aluminum	\$382.50

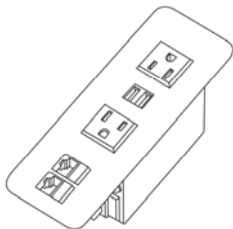
COVE RJ2 DAISYLINK	PART NUMBER	FINISH	LIST PRICE
	COV-RJ2-2U-41GW	Gloss White	\$315.00
	COV-RJ2-2U-41-S	Silver Pearl	\$315.00
	COV-RJ2-2U-41-B	Black	\$315.00
	COV-RJ2-2U-41AL	Clear Brushed Aluminum	\$382.50

-See page 38 for Starter Cable and Interconnecting Cable Options.

**TABLE REQUIREMENTS:**

**COVE LG**

Table Thickness..... .25" x 1.50"

Table Cutout.....2.5" x 6.0"

**COVE RJ & RJ2**

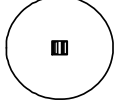

Table Thickness..... .25" x 1.50"

Table Cutout.....2.0" x 6.75"

DATA OPTIONS SOLD SEPARATELY		
Can be inserted into the Data Knock Outs in the Units to Upgrade Communication Capabilities		
PART NUMBER	DESCRIPTION	LIST PRICE
RJ45-B	RJ45 Cat 6 Data Jack	\$57.50
HDMI-KEY-B	HDMI F/F Keystone Jack-Black	\$61.25
USB-KEY-20AA-B	USB 2.0 Keystone Type A/A—Black	\$133.50
USB-KEY-20AA-W	USB 2.0 Keystone Type A/A—White	\$62.25
	*Used for transferring data not charging	

ETL Listed

# RETRO SERIES- COVE™ MINI

2 USB	PART NUMBER	FINISH	LIST PRICE
	COV-SM-R-UGW108 COV-SM-R-U-S108 COV-SM-R-U-B108	Gloss White Silver Pearl Black	\$267.50
	COV-SM-U-GW-108 COV-SM-U-S-108 COV-SM-U-B-108 COV-SM-U-AL-108	Gloss White Silver Pearl Black Clear Brushed Aluminum	\$267.50 \$267.50 \$267.50 \$317.50

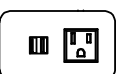
1 POWER, 2 USB	PART NUMBER	FINISH	LIST PRICE
	COV-SM-R1UGW108 COV-SM-R-1US108 COV-SM-R-1UB108	Gloss White Silver Pearl Black	\$247.50
	COV-SM-1U-GW108 COV-SM-1U-S-108 COV-SM-1U-B-108 COV-SM-1U-AL108	Gloss White Silver Pearl Black Clear Brushed Aluminum	\$247.50 \$247.50 \$247.50 \$317.50

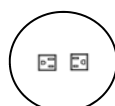
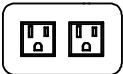
2 POWER ONLY	PART NUMBER	FINISH	LIST NET PRICE
	COV-SM-R-2GW108 COV-SM-R-2-S108 COV-SM-R-2-B108	Gloss White Silver Pearl Black	\$210.00
	COV-SM-2-GW-108 COV-SM-2-S-108 COV-SM-2-B-108 COV-SM-2-AL-108	Gloss White Silver Pearl Black Clear Brushed Aluminum	\$210.00 \$210.00 \$210.00 \$277.50

CORD LENGTH OPTION FEES	
COVE STANDARD CORD LENGTH = 108"	
36"	+ \$13.75
72"	+ \$13.75
144"	+ \$18.75
180"	+ \$25.00

**NOTE:** One Time \$295.00 Custom Cord Length Fee for all non-standard cord length requests

ETL Listed  
108" Cord Standard

**TABLE REQUIREMENTS:**

Table Thickness..... .50" - 2.00"

Table Cutout.....3.27" x 1.90"

# RETRO SERIES CORDED— VILLA™ LG

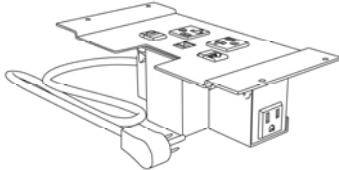
VILLA LG POWER BASES	PART NUMBER	CONFIGURATION	FINISH	LIST PRICE
	VIL-LG-UDKOGW72 VIL-LG-U-DKOS72 VIL-LG-U-DKOB72	VILLA LG Power Base with 2 Power, Convenience Outlet, 2 2.1 AMP USB, 2 Data Knockouts, 72" Power Cord	Gloss White Silver Pearl Black	\$270.00

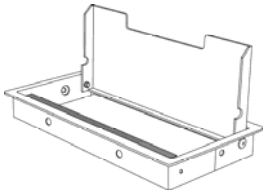
VILLA LG GROMMETS	PART NUMBER	FINISH	LIST PRICE
	VIL-GROM-LG-GW VIL-GROM-LG-S VIL-GROM-LG-B VIL-GROM-LG-AL	Gloss White Silver Pearl Black Clear Brushed Aluminum	\$110.00 \$110.00 \$110.00 \$220.00

VILLA LG DATA OPTIONS		
Can be inserted into the Data Knock Outs in the Units to Upgrade Communication Capabilities		
PART NUMBER	DESCRIPTION	LIST PRICE
RJ45-B	RJ45 Cat 6 Data Jack	\$57.50
HDMI-KEY-B	HDMI F/F Keystone Jack-Black	\$61.25
USB-KEY-20AA-B	USB 2.0 Keystone Type A/A—Black	\$133.50
USB-KEY-20AA-W	USB 2.0 Keystone Type A/A—White	\$62.25
	*Used for transferring data not charging	

CORD LENGTH OPTIONS FEES	
VILLA LG STANDARD LENGTH = 72"	
36"	+ \$13.75
108"	+ \$13.75
144"	+ \$18.75
180"	+ \$25.00

**NOTE:** One Time \$295.00 Custom Cord Length Fee for all non-standard cord length requests

ETL Listed  
72" Cord Standard

**TABLE REQUIREMENTS:**

Table Thickness..... .75" - 2.0:  
Table Cutout.....4.0" x 8.0"

# RETRO SERIES DAISYLINK™ SYSTEM— VILLA™ LG

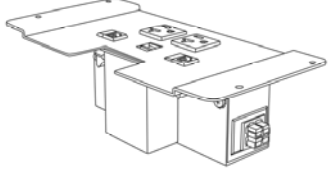
VILLA LG DAISYLINK POWER BASES	PART NUMBER	CONFIGURATION	FINISH	LIST PRICE
	VIL-LG-41UDKOGW VIL-LG-41-UDKOS VIL-LG-41-UDKOB	DaisyLink VILLA LG Power Base, with 2 Power, 2 2.1 AMP USB, 2 Data Knockouts, Circuit 1	Gloss White Silver Pearl Black	\$245.00

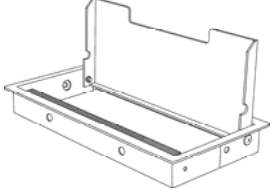
VILLA LG GROMMETS	PART NUMBER	FINISH	LIST PRICE
	VIL-GROM-LG-GW VIL-GROM-LG-S VIL-GROM-LG-B VIL-GROM-LG-AL	Gloss White Silver Pearl Black Clear Brushed Aluminum	\$110.00 \$110.00 \$110.00 \$220.00

\* Villa LG Grommets only used with Villa LG Power Bases.

DATA OPTIONS SOLD SEPARATELY Can be inserted into the Data Knock Outs in the Units to Upgrade Communication Capabilities		
PART NUMBER	DESCRIPTION	LIST PRICE
RJ45-B	RJ45 Cat 6 Data Jack	\$57.50
HDMI-KEY-B	HDMI F/F Keystone Jack-Black	\$61.25
USB-KEY-20AA-B	USB 2.0 Keystone Type A/A—Black	\$133.50
USB-KEY-20AA-W	USB 2.0 Keystone Type A/A—White *Used for transferring data not charging	\$62.25

Change the “1” to a “2” to Specify Circuit 2.  
ETL Listed

**TABLE REQUIREMENTS:**

Table Thickness..... .75” - 2.0:

Table Cutout.....4.0” x 8.0”

-See page 38 for Starter Cable and Interconnecting Cable Options.

# VILLA LG GROMMETS

Stylish Accessories.

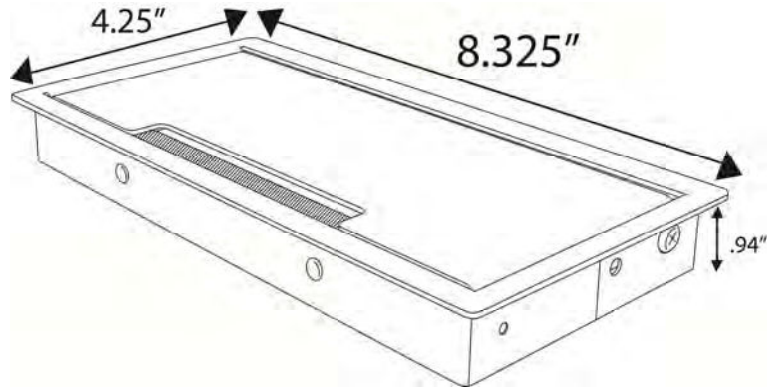

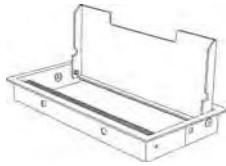
VILLA LG GROMMETS	PART NUMBER	FINISH	LIST PRICE
	VIL-GROM-LG-GW	Gloss White	\$110.00
	VIL-GROM-LG-S	Silver Pearl	\$110.00
	VIL-GROM-LG-B	Black	\$110.00
	VIL-GROM-LG-AL	Clear Brushed Aluminum	\$220.00

ETL Listed

**TABLE REQUIREMENTS:**

Table Thickness..... .75" - 2.0:

Table Cutout.....4.0" x 8.0"

# RUNABOUT

Accessorize Your Tabletop.

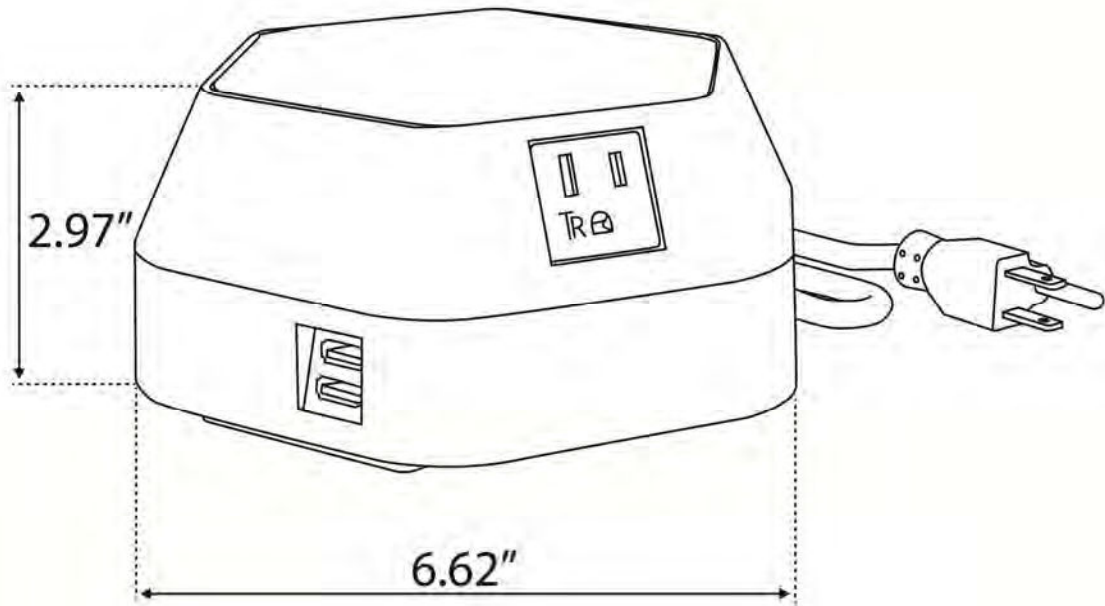

CONFIGURATION	PART NUMBER	FINISH	LIST PRICE
3 Power, 6 USB	RUN-3-6U-B-108	Black	\$287.50
	RUN-3-6U-W-108	White	\$287.50
	RUN-3-6U-GY-108	Grey	\$287.50
	RUN-3-6U-LB-108	Light Blue	\$287.50
	RUN-3-6U-LG-108	Light Green	\$287.50
	RUN-3-6U-SY-108	Sulfur Yellow	\$287.50
	RUN-3-6U-PO-108	Pure Orange	\$287.50
	RUN-3-6U-SR-108	Signal Red	\$287.50

ETL Listed

**PRODUCT INFORMATION:**

Unit Depth ..... .67"—.83"  
 Standard Table Thickness..... .71" - 1.97"  
 Table Cutout..... 80mm Round



# SANDBAR™ – SINGLE SIDED

Clean and Simple Convenience

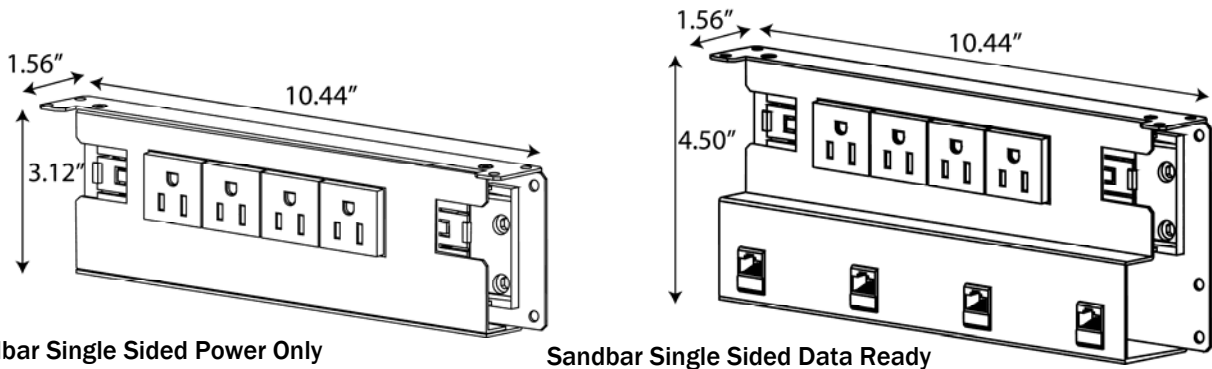

Sandbar Single Sided Power Only

Sandbar Single Sided Data Ready

SANDBAR DATA READY			
PART NUMBER	CONFIGURATION	FINISH	LIST PRICE
84 SBS-B-12IG4 84 SBS-S-12IG4	Single Sided Quad Power Bar with Circuits 1,2,3IG & 4 Receptacles. Knockouts for 4 RJ45 Cat 6 Data Jacks.	Black Silver	\$275.00
84 SBS-B-1111 84 SBS-S-1111	Single Sided Quad Power Bar with 4 Circuit 1 Receptacles. Knockouts for 4 RJ45 Cat 6 Data Jacks.	Black Silver	
84 SBSB1C2CIG4 84 SBS-S1C2C34	Single Sided Quad Power Bar with Circuits 1 & 2 Controlled, Circuit 3IG, Circuit 4 Receptacles. Knockouts for 4 RJ45 Cat 6 Data Jacks.	Black Silver	
84 SBS-B123C4C 84 SBS-S123C4C	Single Sided Quad Power Bar with Circuits 1 & 2,Circuits 3 & 4 Controlled Receptacles. Knockouts for 4 RJ45 Cat 6 Data Jacks.	Black Silver	

SANDBAR POWER ONLY			
PART NUMBER	CONFIGURATION	FINISH	LIST PRICE
84 SBSPB-12IG4 84 SBSPS-12IG4	Single Sided Quad Power Bar with Circuits 1,2,3IG, 4 Receptacles.	Black Silver	\$262.50
84 SBSPB-1111 84 SBSPS-1111	Single Sided Quad Power Bar with 4 Circuit 1 Receptacles.	Black Silver	
84SBSPB1C2CIG4 84 SBSPS1C2C34	Single Sided Quad Power Bar with Circuits 1 & 2 Controlled, Circuit 3IG, Circuit 4 Receptacles.	Black Silver	
84 SBSPB123C4C 84 SBSPS123C4C	Single Sided Quad Power Bar with Circuits 1 & 2,Circuits 3 & 4 Controlled Receptacles.	Black Silver	

PART NUMBER	TELECOM PLATE BRACKET	FINISH	LIST PRICE
I PLY S DATA 1	Bracket for One Telecom Plate	Black	\$69.00
I PLY S DATA	Bracket for Two Telecom Plates	Black	\$74.75

**TABLE REQUIREMENTS:**

Table Cutout.....Mounts Beneath the Table Surface

Data Sold Separately

Cables & Power Infeed Sold Separately

**Innovative Power + Data Solutions**

10 Mountain View Drive • Shelton, CT 06484 • P:800.521.3175 • F:203.924.6687 • www.electri-cable.com

# SANDBAR™ – DOUBLE SIDED

Clean and Simple Convenience

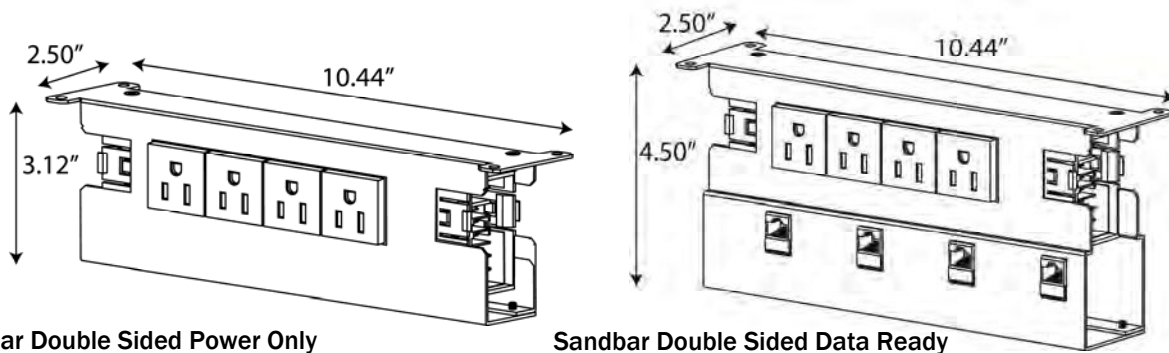

Sandbar Double Sided Power Only

Sandbar Double Sided Data Ready

SANDBAR DATA READY			
PART NUMBER	CONFIGURATION	FINISH	LIST PRICE
84 SBD-B-12IG4 84 SBD-S-12IG4	Double Sided Quad Power Bar with Circuits 1,2,3IG, 4 Receptacles. Knockouts for 8 RJ45 Cat 6 Data Jacks.	Black Silver	\$322.50
84 SBD-B-1111 84 SBD-S-1111	Double Sided Quad Power Bar with 4 Circuit 1 Receptacles. Knockouts for 8 RJ45 Cat 6 Data Jacks.	Black Silver	
84 SBDB1C2CIG4 84 SBD-S1C2C34	Double Sided Quad Power Bar with Circuits 1 & 2 Controlled, Circuit 3IG, Circuit 4 Receptacles. Knockouts for 8 RJ45 Cat 6 Data Jacks.	Black Silver	
84 SBD-B123C4C 84 SBD-S123C4C	Double Sided Quad Power Bar with Circuits 1 & 2,Circuits 3 & 4 Controlled Receptacles. Knockouts for 8 RJ45 Cat 6 Data Jacks.	Black Silver	

SANDBAR POWER ONLY			
PART NUMBER	CONFIGURATION	FINISH	LIST PRICE
84 SBDPB-12IG4 84 SBDPS-12IG4	Double Sided Quad Power Bar with Circuits 1,2,3IG, 4 Receptacles.	Black Silver	\$307.50
84 SBDPB-1111 84 SBDPS-1111	Double Sided Quad Power Bar with 4 Circuit 1 Receptacles.	Black Silver	
84SBDPB1C2CIG4 84 SBDPS1C2C34	Double Sided Quad Power Bar with Circuits 1 & 2 Controlled, Circuit 3IG, Circuit 4 Receptacles.	Black Silver	
84 SBDPB123C4C 84 SBDPS123C4C	Double Sided Quad Power Bar with Circuits 1 & 2,Circuits 3 & 4 Controlled Receptacles.	Black Silver	

PART NUMBER	TELECOM PLATE BRACKET	FINISH	LIST PRICE
I PLY S DATA 1	Bracket for One Telecom Plate	Black	\$69.00
I PLY S DATA	Bracket for Two Telecom Plates	Black	\$74.75

**TABLE REQUIREMENTS:**

Table Cutout.....Mounts Beneath the Table Surface

Data Sold Separately

Cables & Power Infeed Sold Separately

# SAND DOLLAR

Stylish Accessories.

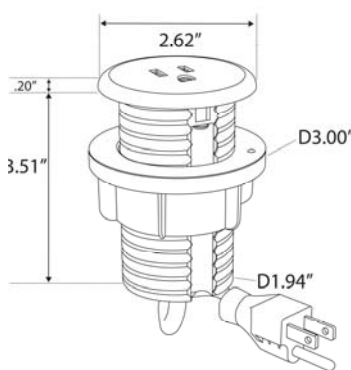

POWER ONLY

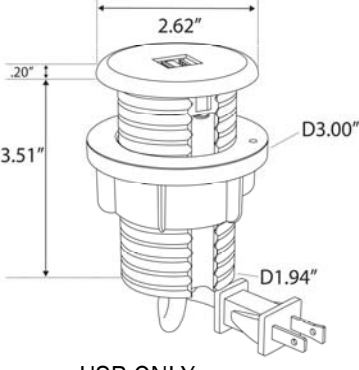

USB ONLY

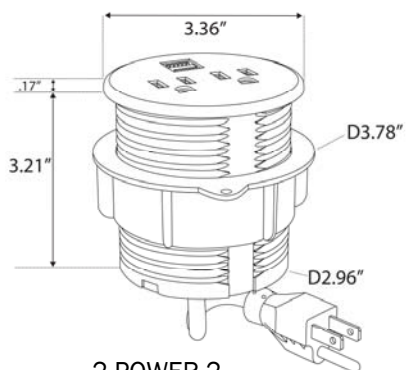

2 POWER 2  
USB

2" Sand Dollar Configurations	PART NUMBER	FINISH	LIST PRICE
1 Power	SAN-2-1-B-72	Black	\$65.00
	SAN-2-1-W-72	White	
	SAN-2-1-GY-72	Grey	
	SAN-2-1-LB-72	Light Blue	
	SAN-2-1-LG-72	Light Green	
	SAN-2-1-SY-72	Sulfur Yellow	
	SAN-2-1-PO-72	Pure Orange	
	SAN-2-1-SR-72	Signal Red	
2 USB	SAN-2-U-B-72	Black	\$165.00
	SAN-2-U-W-72	White	
	SAN-2-U-GY-72	Grey	
	SAN-2-U-LB-72	Light Blue	
	SAN-2-U-LG-72	Light Green	
	SAN-2-U-SY-72	Sulfur Yellow	
	SAN-2-U-PO-72	Pure Orange	
	SAN-2-U-SR-72	Signal Red	

3" Sand Dollar Configuration	PART NUMBER	FINISH	LIST PRICE
2 Power, 2 USB	SAN-3-2U-B-72	Black	\$175.00
	SAN-3-2U-W-72	White	
	SAN-3-2U-GY-72	Grey	
	SAN-3-2U-LB-72	Light Blue	
	SAN-3-2U-LG-72	Light Green	
	SAN-3-2U-SY-72	Sulfur Yellow	
	SAN-3-2U-PO-72	Pure Orange	
	SAN-3-2U-SR-72	Signal Red	

**PRODUCT INFORMATION:**

Table Cutout.....60mm or 80mm  
Table Thickness.....0.25"– 2.0"

ETL Listed

# SECLUSION G2

2 Power Configurations.  
Mix and Match Power, USB Charging, and Data

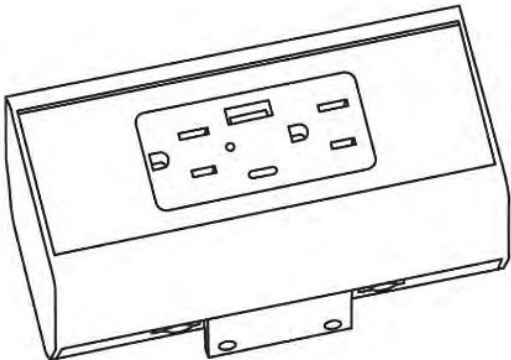

\*Telecom Plates sold separately, see page 100

PART NUMBER	POWER & DATA OPTIONS	LIST PRICE
SEC-2-XX-YY	2 Power	\$210.00
SEC-2D-XX-YY	2 Power, 1 Telecom Plate Knockout	\$210.00
SEC-2U-XX-YY	2 Power, 2 USB	\$275.00
SEC-2UD-XX-YY	2 Power, 2 USB, 1 Telecom Plate Knockout	\$275.00
SEC-2U2C-XX-YY	2 Power, 2 USB-C	\$340.00
SEC-2U2CD-XX-YY	2 Power, 2 USB-C, 1 Telecom Plate Knockout	\$340.00
SEC-2UAC-XX-YY	2 Power, 1 USB, 1 USB-C	\$327.50
SEC-2UACD-XX-YY	2 Power, 1 USB, 1 USB-C, 1 Telecom Plate Knockout	\$327.50

FINISH/CORD OPTIONS			
XX = FINISH		YY = CORD LENGTH*	
<b>S</b> - Silver	+ \$0.00	<b>72</b> - 72"	+ \$0.00
<b>B</b> - Black	+ \$0.00	<b>9</b> - 108"	+ \$13.75
<b>GW</b> - Gloss White	+ \$0.00	<b>12</b> - 144"	+ \$18.75
<b>GB</b> - Gloss Black	+ \$0.00		
<b>LB</b> - Light Blue	+ \$12.50		
<b>LG</b> - Light Green	+ \$12.50		
<b>PO</b> - Pure Orange	+ \$12.50		
<b>SR</b> - Signal Red	+ \$12.50		
<b>SY</b> - Sulfur Yellow	+ \$12.50		
<b>TX</b> - Tuxedo	+ \$12.50		

**NOTE:** One Time \$295.00 Custom Cord Length Fee for all non-standard cord length requests

ETL Listed

**PRODUCT INFORMATION:**

Hardwire Units Available.  
Product Dimensions: See Specification and Ordering Information  
Table Thickness..... .75"- 1.75"  
Table Cutout.....None  
Seclusion Mounting Accessories on Page 84

# SECLUSION G2

4 Power Configurations.

Mix and Match Power, USB Charging, and Data

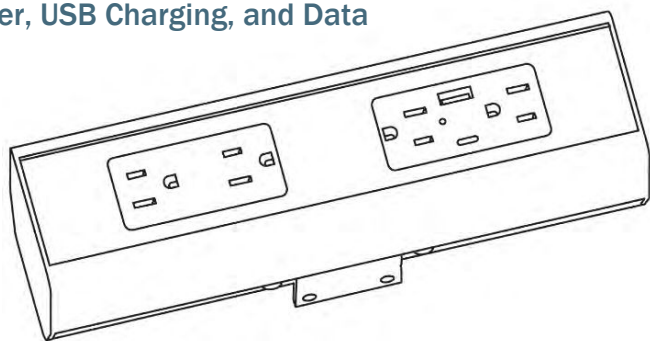

\*Telecom Plates sold separately, see page 100

PART NUMBER	POWER & DATA OPTIONS	LIST PRICE
SEC-4-XX-YY	4 Power	\$235.00
SEC-4D-XX-YY	4 Power, 1 Telecom Plate Knockout	\$235.00
SEC-4U-XX-YY	4 Power, 2 USB	\$327.50
SEC-4U2C-XX-YY	4 Power, 2 USB-C	\$405.00
SEC-4U2CD-XX-YY	4 Power, 2 USB-C, 1 Telecom Plate Knockout	\$405.00
SEC-4UAC-XX-YY	4 Power, 1 USB, 1 USB-C	\$380.00
SEC-4UACD-XX-YY	4 Power, 1 USB, 1 USB-C, 1 Telecom Plate Knockout	\$380.00
SEC-4U2AC-XX-YY	4 Power, 2 USB, 2 USB-C	\$445.00
SEC-4U2ACD-XX-YY	4 Power, 2 USB, 2 USB-C, 1 Telecom Plate Knockout	\$445.00
SEC-4UD-XX-YY	4 Power, 2 USB, 1 Telecom Plate Knockout	\$327.50
SEC-44U-XX-YY	4 Power, 4USB	\$405.00
SEC-44UD-XX-YY	4 Power, 4 USB, 1 Telecom Plate Knockout	\$405.00

FINISH/CORD OPTIONS			
XX = FINISH		YY = CORD LENGTH*	
<b>S</b> - Silver	+ \$0.00	<b>72</b> - 72"	+ \$0.00
<b>B</b> - Black	+ \$0.00	<b>9</b> - 108"	+ \$13.75
<b>GW</b> - Gloss White	+ \$0.00	<b>12</b> - 144"	+ \$18.75
<b>GB</b> - Gloss Black	+ \$0.00		
<b>LB</b> - Light Blue	+ \$12.50		
<b>LG</b> - Light Green	+ \$12.50		
<b>PO</b> - Pure Orange	+ \$12.50		
<b>SR</b> - Signal Red	+ \$12.50		
<b>SY</b> - Sulfur Yellow	+ \$12.50		
<b>TX</b> - Tuxedo	+ \$12.50		

**NOTE:** One Time \$295.00 Custom Cord Length Fee for all non-standard cord length requests

ETL Listed

**PRODUCT INFORMATION:**

Hardwire Units Available.

Product Dimensions: See Specification and Ordering Information

Table Thickness..... .75"- 1.75"

Table Cutout.....None

Seclusion Mounting Accessories on page 84

**Innovative Power + Data Solutions**

10 Mountain View Drive • Shelton, CT 06484 • P:800.521.3175 • F:203.924.6687 • www.electri-cable.com

# SECLUSION G2

6 Power Configurations.  
Mix and Match Power, USB Charging, and Data

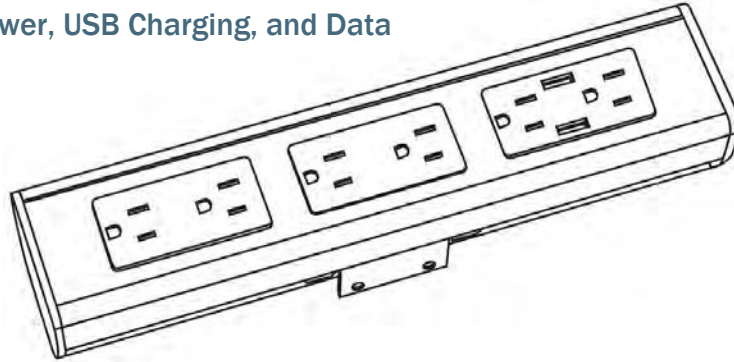

\*Telecom Plates sold separately, see page 100

PART NUMBER	POWER & DATA OPTIONS	LIST PRICE
SEC-6-XX-YY	6 Power	\$287.50
SEC-6D-XX-YY	6 Power, 1 Telecom Plate Knockout	\$287.50
SEC-6U-XX-YY	6 Power, 2 USB	\$405.00
SEC-6UD-XX-YY	6 Power, 2 USB, 1 Telecom Plate Knockout	\$405.00
SEC-6U2C-XX-YY	6 Power, 2 USB-C	\$430.00
SEC-6U2CD-XX-YY	6 Power, 2 USB-C, 1 Telecom Plate Knockout	\$430.00
SEC-6UAC-XX-YY	6 Power, 1 USB, 1 USB-C	\$420.00
SEC-6UACD-XX-YY	6 Power, 1 USB, 1 USB-C, 1 Telecom Plate Knockout	\$420.00
SEC-6U2AC-XX-YY	6 Power, 2 USB, 2 USB-C	\$510.00
SEC-6U2ACD-XX-YY	6 Power, 2 USB, 2 USB-C, 1 Telecom Plate Knockout	\$510.00

FINISH/CORD OPTIONS			
XX = FINISH		YY = CORD LENGTH*	
<b>S</b> - Silver	+ \$0.00	<b>72</b> - 72"	+ \$0.00
<b>B</b> - Black	+ \$0.00	<b>9</b> - 108"	+ \$13.75
<b>GW</b> - Gloss White	+ \$0.00	<b>12</b> - 144"	+ \$18.75
<b>GB</b> - Gloss Black	+ \$0.00		
<b>LB</b> - Light Blue	+ \$12.50		
<b>LG</b> - Light Green	+ \$12.50		
<b>PO</b> - Pure Orange	+ \$12.50		
<b>SR</b> - Signal Red	+ \$12.50		
<b>SY</b> - Sulfur Yellow	+ \$12.50		
<b>TX</b> - Tuxedo	+ \$12.50		

**NOTE:** One Time \$295.00 Custom Cord Length Fee for all non-standard cord length requests

ETL Listed

**PRODUCT INFORMATION:**

Hardwire Units Available.  
Product Dimensions: See Specification and Ordering Information  
Table Thickness..... .75"- 1.75"  
Table Cutout.....None  
Seclusion Mounting Accessories on page 84

# SECLUSION® 60 WATT SERIES



PART NUMBER	POWER & DATA OPTIONS	LIST PRICE 1-25 UNITS	LIST PRICE 26-250 UNITS	LIST PRICE 251+ UNITS
SEC-2UC60-XX-YY	2 power, 60W USB A/C	\$412.50	Call for Pricing	Call for Pricing
SEC-2UC60D-XX-YY	2 power, 60W USB A/C, 1 TKO	\$417.50	Call for Pricing	Call for Pricing
PART NUMBER	POWER & DATA OPTIONS	LIST PRICE 1-25 UNITS	LIST PRICE 26-250 UNITS	LIST PRICE 251+ UNITS
SEC-4UC60-XX-YY	4 power, 60W USB A/C	\$465.00	Call for Pricing	Call for Pricing
SEC-4UC60D-XX-YY	4 power, 60W USB A/C, 1 TKO	\$470.00	Call for Pricing	Call for Pricing
PART NUMBER	POWER & DATA OPTIONS	LIST PRICE 1-25 UNITS	LIST PRICE 26-250 UNITS	LIST PRICE 251+ UNITS
SEC-6UC60-XX-YY	6 power, 60W USB A/C	\$505.00	Call for Pricing	Call for Pricing
SEC-6UC60D-XX-YY	6 power, 60W USB A/C, 1 TKO	\$510.00	Call for Pricing	Call for Pricing

\*Please note: images represent 2 power options only.

ETL Listed

FINISH/CORD OPTIONS			
XX = FINISH		YY = CORD LENGTH*	
<b>S</b> - Silver	+ \$0.00	<b>72</b> - 72"	+ \$0.00
<b>B</b> - Black	+ \$0.00	<b>9</b> - 108"	+ \$5.50
<b>GW</b> - Gloss White	+ \$0.00	<b>12</b> - 144"	+ \$7.50
<b>GB</b> - Gloss Black	+ \$0.00		
<b>LB</b> - Light Blue	+ \$5.00		
<b>LG</b> - Light Green	+ \$5.00		
<b>PO</b> - Pure Orange	+ \$5.00		
<b>SR</b> - Signal Red	+ \$5.00		
<b>SY</b> - Sulfur Yellow	+ \$5.00		
<b>TX</b> - Tuxedo	+ \$5.00		

**PRODUCT INFORMATION:**



Product Dimensions: See Specification and Ordering Information  
 Standard Cord Length: 72"  
 Table Cutout.....See Installation Instructions

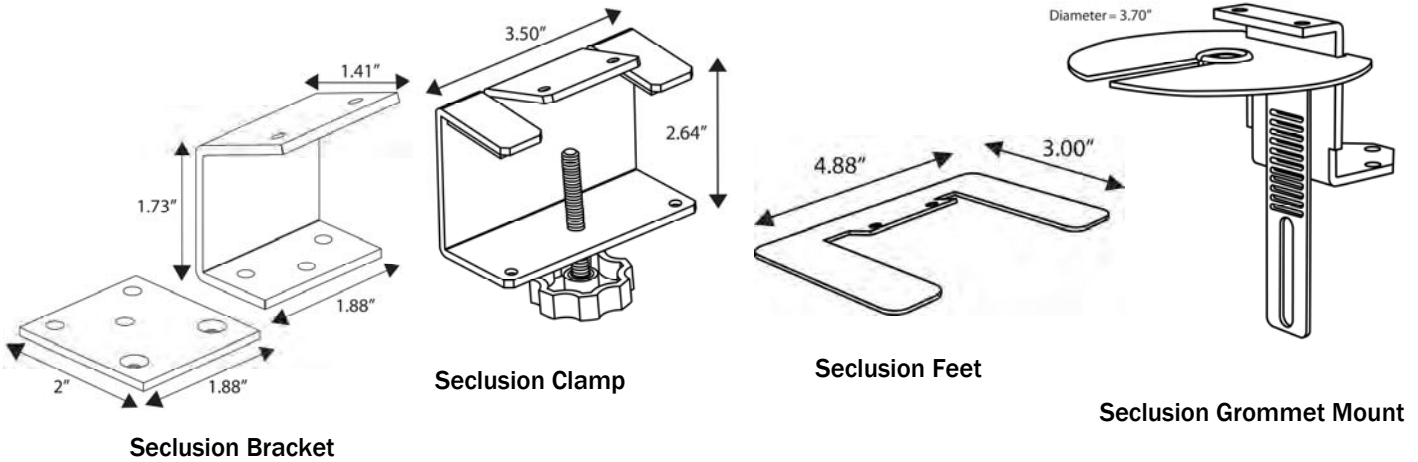

# SECLUSION® G2— MOUNTING ACCESSORIES

Choice of One Included Complimentary with Each Seclusion® Unit

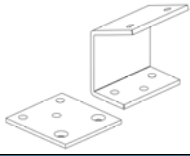
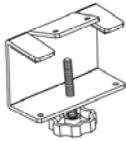

No Charge with Seclusion Purchase. \$24.88 Replacement Fee or if Ordered Separately.		
SECLUSION BRACKET	PART NUMBER	FINISH
	SEC-BRKT SEC-BRKT-GW	Black Gloss White
SECLUSION CLAMP	PART NUMBER	FINISH
	SEC-CLAMP SEC-CLAMP-GW	Black Gloss White
SECLUSION FEET	PART NUMBER	FINISH
	SEC-FEET-B SEC-FEET-GW	Black Gloss White
SECLUSION GROMMET MOUNT	PART NUMBER	FINISH
	SEC-GROM-MT-B SEC-GROM-MT-GW	Black Gloss White

**PRODUCT INFORMATION:**

Optional Accessories to pair with any Seclusion® unit

Seclusion Bracket accommodates table thicknesses 0.75"-1.75"

Seclusion Clamp accommodates table thicknesses 0.5"- 2.00"

Seclusion Grommet Mount fits openings 2" (50.8mm)- 3.15" (80mm) and table thicknesses of 1" (25.4mm) - 1.5" (38.3mm)

# SECLUSION® G2 SERIES™ HIDE IT KIT

## Wire Management and Storage

Large Hide It Kit:

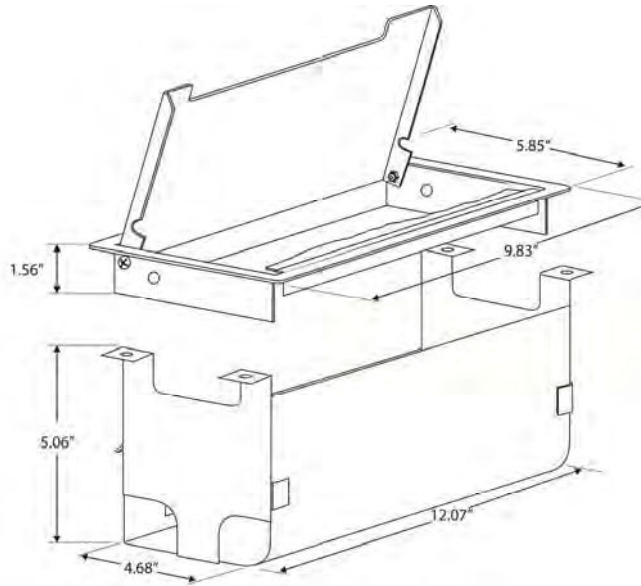

Small Hide It Kit:

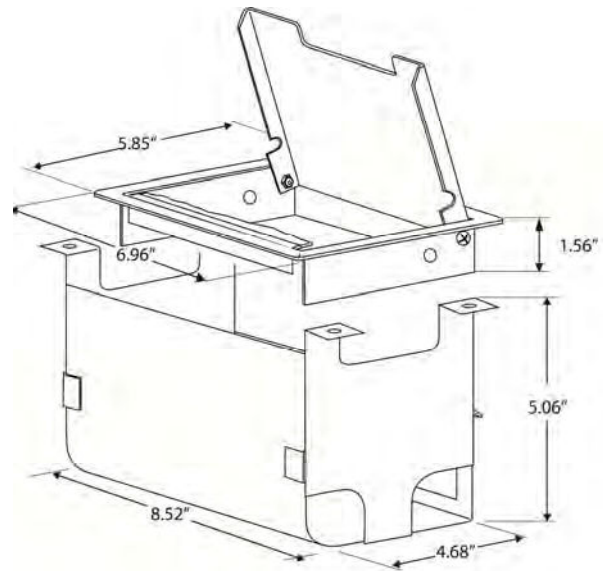

LARGE HIDE IT KIT	DESCRIPTION	GROMMET FINISH	LIST PRICE
HIDEIT-L-S-K	Large Hide It Kit, includes 9"x5" grommet and cable basket with two telecom plate cutouts.	Silver Pearl	\$210.00
HIDEIT-L-B-K		Black	\$210.00
HIDEIT-L-GW-K		Gloss White	\$210.00
HIDEIT-L-AL-K		Aluminum	\$275.00
SMALL HIDE IT KIT	DESCRIPTION	GROMMET FINISH	LIST PRICE
HIDEIT-S-S-K	Small Hide It Kit, includes 6"x5" grommet and cable basket with two telecom plate cutouts.	Silver Pearl	\$195.00
HIDEIT-S-B-K		Black	\$195.00
HIDEIT-S-GW-K		Gloss White	\$195.00
HIDEIT-S-AL-K		Aluminum	\$262.00

\*Seclusion G2 Units sold separately, See page 86  
 \*Telecom Plates sold separately, see page 100  
 Hide It Baskets are always Black

**PRODUCT INFORMATION:**

Standard Table Thickness..... .75" - 1.50"  
 Table Cutout.....See installation instructions

# HIDE IT GROMMETS

Stylish Accessories.

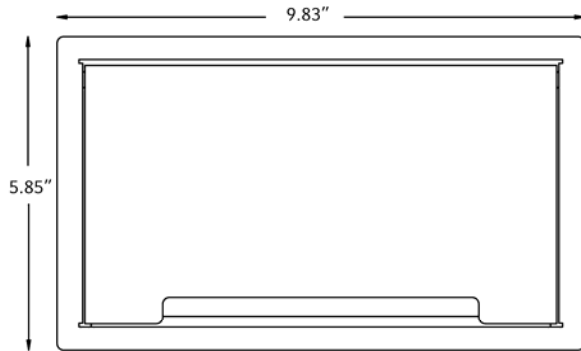

LARGE GROMMET

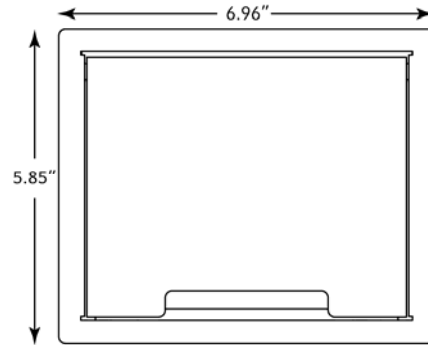

SMALL GROMMET

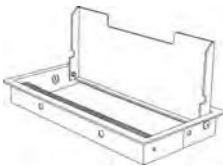
LARGE GROMMETS	PART NUMBER	FINISH	LIST PRICE
	HID-GROM-L-GW	Gloss White	\$130.00
	HID-GROM-L-S	Silver Pearl	\$130.00
	HID-GROM-L-B	Black	\$130.00
	HID-GROM-L-AL	Aluminum	\$195.00

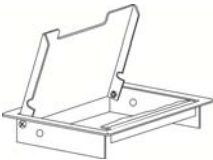
SMALL GROMMETS	PART NUMBER	FINISH	LIST PRICE
	HID-GROM-S-GW	Gloss White	\$110.00
	HID-GROM-S-S	Silver Pearl	\$110.00
	HID-GROM-S-B	Black	\$110.00
	HID-GROM-S-AL	Aluminum	\$175.00

**TABLE REQUIREMENTS: LARGE GROMMETS**

Table Cutout.....5.3" x 9.25"

**TABLE REQUIREMENTS: SMALL GROMMETS**

Table Cutout.....5.3" x 6.3"

# STO-WAY Recessed

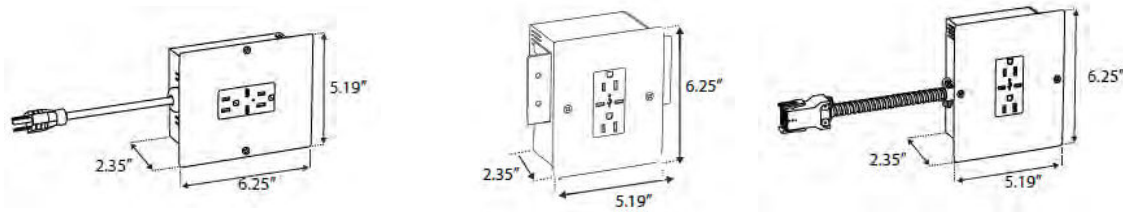

PART NUMBER <i>RECESSED</i>	DESCRIPTION	CORD LENGTH	LIST PRICE	KEY
				STANDARD FINISH OPTIONS
<b>METAL LOCKER: DAISYLINK</b>				<b>XX = FINISH</b> <b>S</b> - Silver Pearl <b>B</b> - Black <b>GW</b> - Gloss White <b>GG</b> - Graphite Grey
STR-2-41-XX-24	Circuit 1: 2 Power	24" Conduit	\$255.00	
STR-2GF-XX-24	Circuit 1: 2 Power GFCI	24" Conduit	\$363.00	
STR-2U-41-XX-24	Circuit 1: 2 Power 2 USB	24" Conduit	\$343.00	
STR-2U2C-41-XX-24	Circuit 1: 2 Power 2 USB-C	24" Conduit	\$363.00	
STR-2UAC-41-XX-24	Circuit 1: 2 Power 1 USB 1USB-C	24" Conduit	\$343.00	
<b>METAL LOCKER: DAISYLINK (NO WHIP)</b>				
STR-2-41-XX	Circuit 1: 2 Power	-	\$255.00	
STR-2GF-XX	Circuit 1: 2 Power GFCI	-	\$363.00	
STR-2U-41-XX	Circuit 1: 2 Power 2 USB	-	\$343.00	
STR-2U2C-41-XX	Circuit 1: 2 Power 2 USB-C	-	\$363.00	
STR-2UAC-41-XX	Circuit 1: 2 Power 1 USB 1USB-C	-	\$343.00	
<b>METAL LOCKER: CORDED</b>				
STR-2-XX-108	2 Power	108" Cord	\$250.00	
STR-2GF-XX-108	2 Power GFCI	108" Cord	\$363.00	
STR-2U-XX-108	2 Power 2 USB	108" Cord	\$343.00	
STR-2U2C-XX-108	2 Power 2 USB-C	108" Cord	\$363.00	
STR-2UAC-XX-108	2 Power 1 USB 1 USB-C	108" Cord	\$343.00	
<b>WOOD LOCKER: DAISYLINK</b>				
STR-W-2-41XX24	Circuit 1: 2 Power	24" Conduit	\$278.00	
STR-W-2GF-41XX24	Circuit 1: 2 Power GFCI	24" Conduit	\$365.00	
STR-W-2U-41-XX24	Circuit 1: 2 Power 2 USB	24" Conduit	\$360.00	
STR-W-2U2C41XX24	Circuit 1: 2 Power 2 USB-C	24" Conduit	\$365.00	
STR-W-2UAC41XX24	Circuit 1: 2 Power 1 USB 1 USB-C	24" Conduit	\$360.00	
<b>WOOD LOCKER: DAISYLINK (NO WHIP)</b>				
STR-W-2-41-XX	Circuit 1: 2 Power	-	\$278.00	
STR-W-2GF-41-XX	Circuit 1: 2 Power GFCI	-	\$365.00	
STR-W-2U-41-XX	Circuit 1: 2 Power 2 USB	-	\$360.00	
STR-W-2U2C-41-XX	Circuit 1: 2 Power 2 USB-C	-	\$365.00	
STR-W-2UAC-41-XX	Circuit 1: 2 Power 1 USB 1 USB-C	-	\$360.00	

**PRODUCT INFORMATION RECESSED VERSION:**

ETL Listed

For Circuit 2 option, replace "41" with "42" in daisylink part number. See page 38 for Interconnecting Cable Options.

Innovative Power + Data Solutions

10 Mountain View Drive • Shelton, CT 06484 • P:800.521.3175 • F:203.924.6687 • www.electri-cable.com

# STO-WAY Recessed Continued...

WOOD LOCKER: CORDED			
STR-W-2-XX-108	2 Power	108" Cord	\$250.00
STR-W-2GF-XX-108	2 Power GFCI	108" Cord	\$363.00
STR-W-2U-XX-108	2 Power 2 USB	108" Cord	\$343.00
STR-W-2U2C-XX108	2 Power 2 USB-C	108" Cord	\$363.00
STR-W-2UAC-XX108	2 Power 1 USB 1 USB-C	108" Cord	\$343.00

# STO-WAY Surface

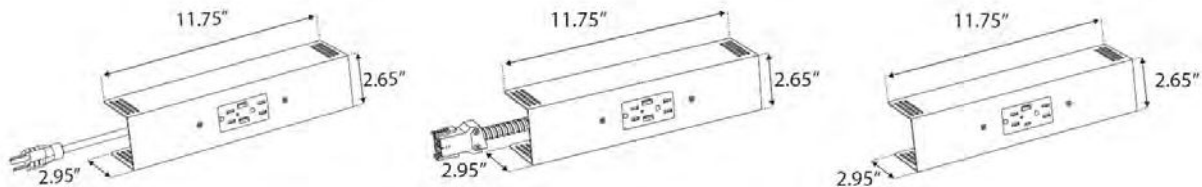

PART NUMBER <i>SURFACE</i>	DESCRIPTION	CORD LENGTH	LIST PRICE	KEY
				STANDARD FINISH OPTIONS
<b>DAISYLINK</b>				<b>XX = FINISH</b> <b>S</b> - Silver Pearl <b>B</b> - Black <b>GW</b> - Gloss White <b>GG</b> - Graphite Grey
STS-2-41-XX-7	Circuit 1: 2 Power	7" Conduit	\$255.00	
STS-2GF-41-XX-7	Circuit 1: 2 Power GFCI	7" Conduit	\$363.00	
STS-2U-41-XX-7	Circuit 1: 2 Power 2 USB	7" Conduit	\$343.00	
STS-2U2C-41-XX-7	Circuit 1: 2 Power 2 USB-C	7" Conduit	\$363.00	
STS-2UAC-41-XX-7	Circuit 1: 2 Power 1 USB 1USB-C	7" Conduit	\$343.00	
<b>DAISYLINK (NO WHIP)</b>				
STS-2-41-XX	Circuit 1: 2 Power	-	\$248.00	
STS-2GF-41-XX	Circuit 1: 2 Power GFCI	-	\$355.00	
STS-2U-41-XX	Circuit 1: 2 Power 2 USB	-	\$333.00	
STS-2U2C-41-XX	Circuit 1: 2 Power 2 USB-C	-	\$355.00	
STS-2UAC-41-XX	Circuit 1: 2 Power 1 USB 1 USB-C	-	\$333.00	
<b>CORDED</b>				
STS-2-XX-108	2 Power	108" Cord	\$250.00	
STS-2GF-XX-108	2 Power GFCI	108" Cord	\$363.00	
STS-2U-XX-108	2 Power 2 USB	108" Cord	\$343.00	
STS-2U2C-XX-108	2 Power 2 USB-C	108" Cord	\$363.00	
STS-2UAC-XX-108	2 Power 1 USB 1 USB-C	108" Cord	\$343.00	

**PRODUCT INFORMATION RECESSED VERSION:**











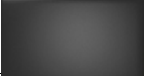



For Circuit 2 options, replace "41" with "42" in DaisyLink part number See page 38 for Interconnecting Cables Options

ETL Listed

# TELECOM PLATES

## Telecom Plate Finishes:

Default color- BL (Black)  
 Replace BL in Telecom Plate Part Number with-  
 GR (Gray) - add \$2.00 to net price  
 WH (White) - add \$3.00 to net price

TOP TELECOM PLATES	PART NUMBER	CONFIGURATION	LIST PRICE
	A-BL	Blank Telecom Plate	\$7.13
	A-BL-A-B	(1) RJ11 Siemon Cat 3 and (1) RJ45 Siemon Cat 6	\$98.13
	A-BL-A-B-102	(1) RJ11 Cat 3 phone, RJ45 Cat 6 Data and USB with 72" patch cord attached	\$159.38
	A-BL-B	(1) RJ45 Siemon Cat 6	\$64.63
	A-BL-B-B	(2) RJ45 Cat 6 Connectors	\$122.13
	A-BL-B-B-C45	(2) RJ45 Cat 6 Connectors and HDMI Female/Female with 36" patch cord attached	\$266.13
	A-BL-B-B-B	(3) RJ45 Cat 6 Connectors	\$179.63
	A-BL-B-B-B-B	(4) RJ45 Cat 6 Connectors	\$237.13
	A-BL-102	(1) USB Type A/A with 72" patch cord attached	\$68.38
	A-BL-102-102	(2) USB Type A/A with 72" patch cord attached	\$129.63
	A-BL-C45	HDMI Female/ Female with 36" patch cord attached	\$151.13
	A-BL-C45-C51	(1) HDMI Female/Female with 36" patch cord attached and 15 Pin HD VGA Female/Female with 60" patch cord attached	\$256.38
	A-BL-C45-C51-L	(1) HDMI Female/Female with 36" patch cord attached, Mini Stereo Inline, and 15 Pin HD VGA Female/Female with 60" patch cord attached	\$297.88
	A-BL-CRDMINDER	Cordminder Plate- (2)- 5/8" Holes and (1)- 7/8" Hole	\$113.75
	KNOCK OUT CHARGE	Knock out charge	\$33.38

# TELECOM PLATE BRACKETS- I PLY

Clean and Simple Convenience

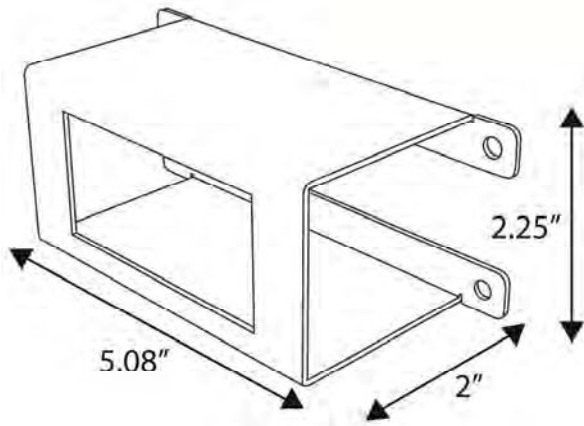

I PLY S DATA 1

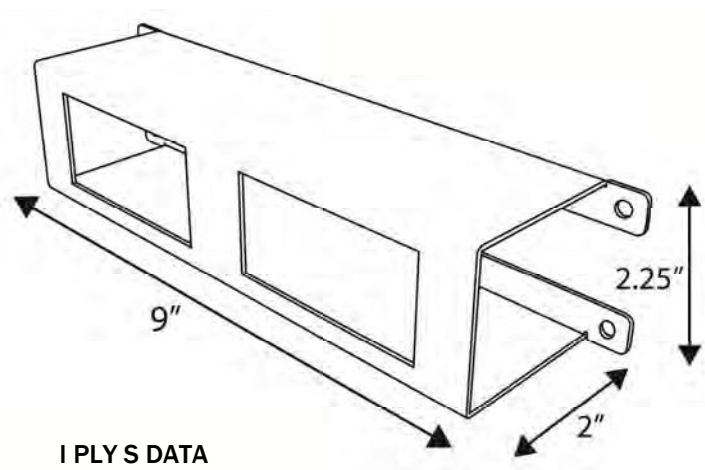

I PLY S DATA

PART NUMBER	CONFIGURATION	FINISH	LIST PRICE
I PLY S DATA 1	Bracket for One Telecom Plate	Black	\$69.00
I PLY S DATA	Bracket for Two Telecom Plates	Black	\$74.75

**TABLE REQUIREMENTS:**

Table Cutout.....Mounts Beneath the Table Surface  
 Telecom Plates sold separately, see page 100



# TOP NOTCH 2

One Great Design.

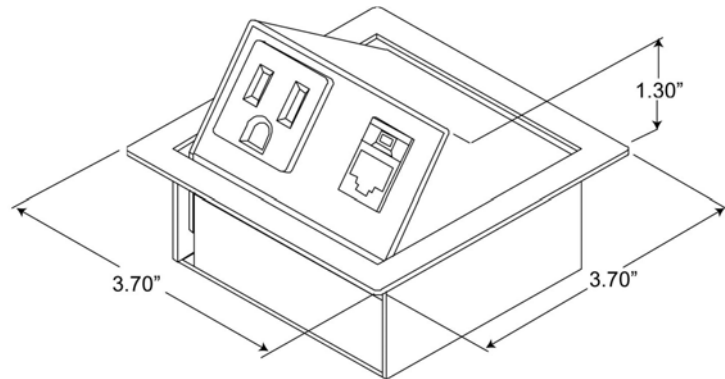

POWER ONLY	PART NUMBER	CONFIGURATION	FINISH	LIST PRICE
	TOP NOTCH2 P BL	2 Power, No Data, Comes with 72" cord	Black Textured	\$265.00
	TOP NOTCH2 P SP		Silver Pearl	\$265.00
	TOP NOTCH2 P SS		Brushed Stainless Steel	\$377.50

POWER AND DATA	PART NUMBER	CONFIGURATION	FINISH	LIST PRICE
	TOP NOTCH2 B BL	1 Power, 1 RJ45 Cat 6 Data, Comes with 72" cord and 72" Patch cords for Data	Black Textured	\$367.50
	TOP NOTCH2 B SP		Silver Pearl	\$367.50
	TOP NOTCH2 B SS		Brushed Stainless Steel	\$440.00

POWER AND DATA	PART NUMBER	CONFIGURATION	FINISH	LIST PRICE
	TOP NOTCH2 U BL	1 Power, 1 USB, comes with 72" cord and 72" patch cord for USB	Black Textured	\$370.00
	TOP NOTCH2 U SP		Silver Pearl	\$370.00
	TOP NOTCH2 U SS		Brushed Stainless Steel	\$427.50
	PWRUSB-20ABB72K	Kit for Powering USB in Top Notch2 U	N/A	\$110.00

UL Listed

**TABLE REQUIREMENTS:**

Table Thickness..... .75"- 1.875"

Table Cutout.....3.4" x 3.4"

# VILLA™ & VILLA™ II CORDED SERIES

Versatility in Design.

## Build Your Own- Power Bases

Replace \_\_ in the Part Number with Appropriate Cord Length: 36", 72", or 108".  
Pricing is standard for all lengths.

See page 119 for Villa Grommets.

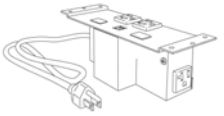
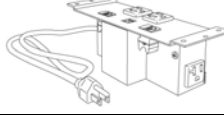
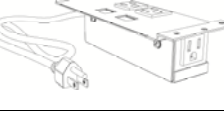
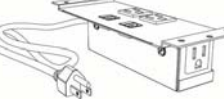
VILLA POWER BASES	PART NUMBER	CONFIGURATION	FINISH	LIST PRICE
	VIL-C-U-DKO-B-__ VIL-C-U-DKO-S-__	2 Power, 2 USB 2.1 AMP charging ports, and knockouts for 2 RJ45 Cat6 Data, 72" cord	Black Silver	\$270.00
	VIL-C-U-D-B-__ VIL-C-U-D-S-__	2 Power, 2 USB 2.1 AMP charging ports, 2 RJ45 Cat6 Data, 72" cord	Black Silver	\$385.00
	VIL-C-DKO-B-__ VIL-C-DKO-S-__	2 Power, Knockouts for 2 RJ45 Cat 6 Data, 72" Cord	Black Silver	\$190.00
	VIL-C-D-B-__ VIL-C-D-S-__	2 Power, 2 RJ45 Cat 6 Data, 72" Cord	Black Silver	\$305.00

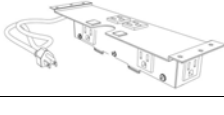
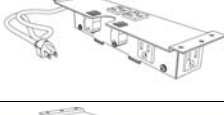
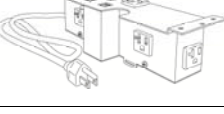
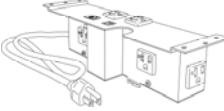
VILLA II POWER BASES	PART NUMBER	CONFIGURATION	FINISH	LIST PRICE
	VIL2-C2-DKOB-__ VIL2-C2-DKOS-__	2 Power Up, 3 Power Below, 2 Knockouts for RJ45, 72" Cord	Black Silver	\$262.50
	VIL2-C2-D-B-__ VIL2-C2-D-S-__	2 Power Up, 3 Power Below, 2 RJ45 Cat 6 Data, 72" Cord	Black Silver	\$377.50
	VIL2-C-U-DKOB-__ VIL2-C-U-DKOS-__ VIL2-C-U-DKOW-__	2 Power Up, 3 Power Below, 2 2.1A USB charging ports, RJ45 Cat 6 Data knockout	Black Silver White	\$342.50
	VIL2-C-U-D-B-__ VIL2-C-U-D-S-__ VIL2-C-U-D-W-__	2 Power Up, 3 Power Below, 2 2.1A USB charging ports, RJ45 Cat 6 Data	Black Silver White	\$400.00

**NON-STANDARD CORD LENGTH OPTIONS FEES**

VILLA I & II STANDARD LENGTH = 36", 72", 108"

144" + \$18.75  
180" + \$25.00

**NOTE:** One Time \$295.00 Custom Cord Length Fee for all non-standard cord length requests

**PRODUCT INFORMATION:**

Product Dimensions: See Specification and Ordering Information

Minimum Table Thickness..... 1.00"

Table Cutout For Villa Grommet..... 3.00" x 5.25"

-Each Villa unit comes with 4 cable clamps and mounting screws.

UL Listed & CSA Certified, or ETL and cETLus Certified

**Innovative Power + Data Solutions**



10 Mountain View Drive • Shelton, CT 06484 • P:800.521.3175 • F:203.924.6687 • www.electri-cable.com

# VILLA UM—CORDED

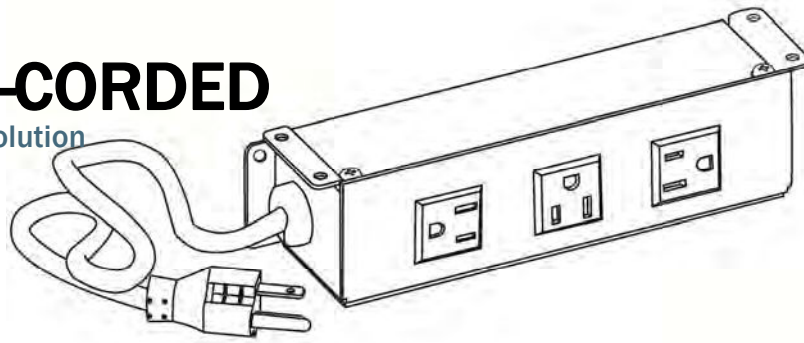
Corded Under Mount Solution

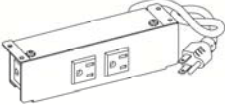
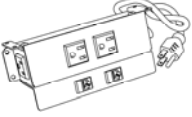
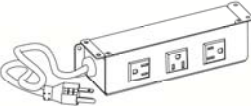
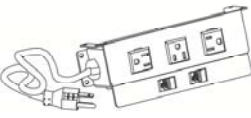
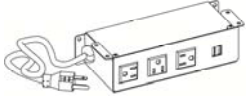
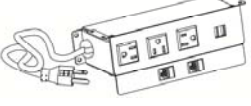
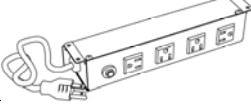

**UNDERMOUNT SOLUTIONS**

VILLA UM CORDED				
	PART NUMBER	DESCRIPTION	FINISH	LIST PRICE
	VIL-UM-C-P-B-72 VIL-UM-C-P-S-72	Villa Under Mount, 2 Power, 1 Convenience Outlet	Black Silver Pearl	\$192.50
	VIL-UM-CPDKOB72 VIL-UM-CPDKOS72	Villa Under Mount, 2 Power, 1 Convenience Outlet, 2 Data Knock- outs	Black Silver Pearl	\$205.00
	VIL-UM-C-3-B-72 VIL-UM-C-3-S-72	Villa Under Mount, 3 Power	Black Silver Pearl	\$215.00
	VIL-UM-C3DKOB72 VIL-UM-C3DKOS72	Villa Under Mount, 3 Power, Knockouts for 2 RJ45 Cat 6 Data	Black Silver Pearl	\$227.50
	VIL-UM-C-3U-B72 VIL-UM-C-3U-S72	Villa Under Mount, 3 Power, 2 2.1amp USB	Black Silver Pearl	\$295.00
	VIL-UMC3UDKOB72 VIL-UMC3UDKOS72	Villa Under Mount, 3 Power, 2 2.1amp USB, Knockouts for 2 RJ45 Cat 6 Data	Black Silver Pearl	\$307.50
	VIL-UM-C-4-B-72 VIL-UM-C-4-S-72	Villa Under Mount, 4 Power	Black Silver Pearl	\$227.50
	VIL-UM-C-U-B-72 VIL-UM-C-U-S-72	Villa Under Mount, 2 2.1amp USB	Black Silver Pearl	\$300.00

**NON-STANDARD CORD LENGTH OPTIONS FEES**

VILLA UM STANDARD LENGTH = 72"

36"	+ \$13.75
108"	+ \$13.75
144"	+ \$18.75
180"	+ \$25.00

**NOTE:** One Time \$295.00 Custom Cord Length Fee for all non-standard cord length requests

Data sold Separately.  
ETL Listed

**TABLE REQUIREMENTS:**

- Product Dimensions.....See Specification and Ordering Information
- Standard Cord Length.....72"
- Minimum Table Thickness.....1.00"
- Table Cutout.....Mounts Beneath The Table Surface

**Innovative Power + Data Solutions**

10 Mountain View Drive • Shelton, CT 06484 • P:800.521.3175 • F:203.924.6687 • [www.electri-cable.com](http://www.electri-cable.com)

# DAISYLINK™ SYSTEM — VILLA™ SERIES

**Power and Data Ready— Quick Kits— Single & Double**  
 Simple and Clean DaisyChain Solution.

**Single Kit Includes:**

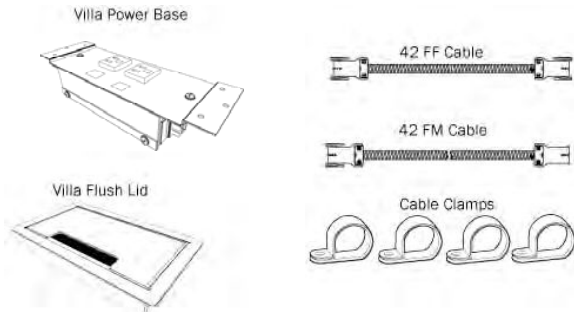

Replace \_\_\_\_ in Single Kit Part Number (K) with 36”, 42”, 48”, 60” or 72” for table length being specified. Pricing is standard for all table lengths.

Change the “1” to a “2” to Specify Circuit 2.

**Double Kit Includes:**

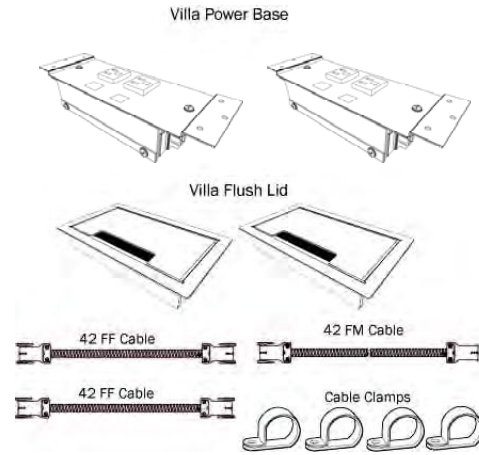

Replace \_\_\_\_ in Double Kit Part Number (DK) with 60”, 72”, 84”, or 96” for table length being specified. Pricing is standard for all table lengths.

**Note:** Cable lengths are 1” longer than the table. Cables extend 1/2” off either side of the table for easy connection. Each Villa unit comes with mounting screws.

FLUSH LID	PART NUMBER	CONFIGURATION	FINISH	LIST PRICE
	VIF-41-DKOB-__K VIF-41-DKOB-__DK	2 Power and Knockouts for 2 RJ45 Cat 6 Data, Flush Lid	Black	\$377.50 \$712.50
	VIF-41-DKOS-__K * VIF-41-DKOS-__DK	2 Power and Knockouts for 2 RJ45 Cat 6 Data, Flush Lid	Silver	\$377.50 \$712.50
	VIF-41-DKOGW-__K VIF-41-DKOGW-__DK	2 Power and Knockouts for 2 RJ45 Cat 6 Data, Flush Lid	Gloss White	\$377.50 \$712.50
	VIF-41-DKOAL-__K VIF-41-DKOAL-__DK	2 Power and Knockouts for 2 RJ45 Cat 6 Data, Flush Lid	Aluminum	\$450.50 \$855.00
	VIF-41-DKOSS-__K VIF-41-DKOSS-__DK	2 Power and Knockouts for 2 RJ45 Cat 6 Data, Flush Lid	Brushed Stainless Steel	\$450.50 \$855.00

LIFT LID	PART NUMBER	CONFIGURATION	FINISH	LIST PRICE
	VIL-41-DKOB-__K VIL-41-DKOB-__DK	2 Power and Knockouts for 2 RJ45 Cat 6 Data, Lift Lid	Black	\$377.50 \$712.50
	VIL-41-DKOS-__K VIL-41-DKOS-__DK	2 Power and Knockouts for 2 RJ45 Cat 6 Data, Lift Lid	Silver	\$377.50 \$712.50
	VIL-41-DKOGW-__K VIL-41-DKOGW-__DK	2 Power and Knockouts for 2 RJ45 Cat 6 Data, Lift Lid	Gloss White	\$377.50 \$712.50

**PRODUCT INFORMATION:**

Product Dimensions: See Specification and Ordering Information  
 Minimum Table Thickness..... 1.00”  
 Table Cutout For Villa Grommet..... 3.00” x 5.25”

See page 38 for Starter Cable and Interconnecting Cable UL Listed & CSA Certified, or ETL and cETLus

**Innovative Power + Data Solutions**

10 Mountain View Drive • Shelton, CT 06484 • P:800.521.3175 • F:203.924.6687 • www.electri-cable.com

# DAISYLINK™ SYSTEM — VILLA™ SERIES

## Power and Data— Quick Kits— Single & Double (Cont.)

Simple and Clean DaisyChain Solution.

### Single Kit Includes:

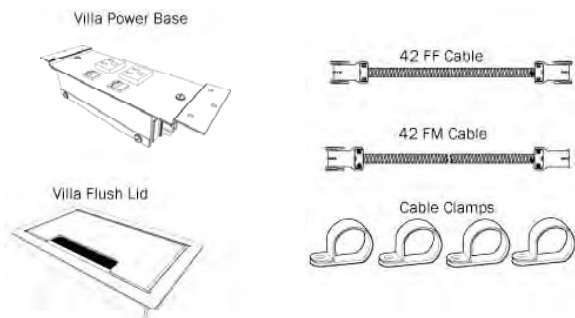

Replace \_\_\_\_ in Single Kit Part Number (K) with 36", 42", 48", 60" or 72" for table length being specified. Pricing is standard for all table lengths.

Change the "1" to a "2" to Specify Circuit 2.

**Note:** Cable lengths are 1" longer than the table. Cables extend 1/2" off either side of the table for easy connection. Each Villa unit comes with mounting screws.

### Double Kit Includes:

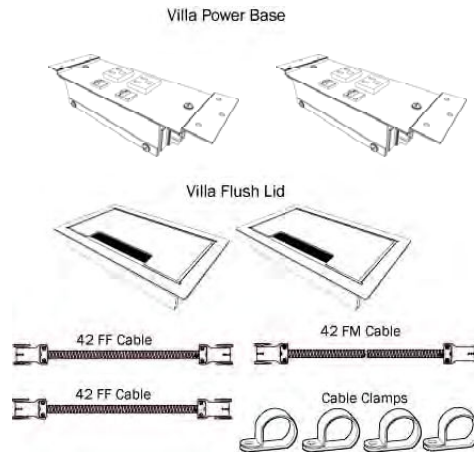

Replace \_\_\_\_ in Double Kit Part Number (DK) with 60", 72", 84", or 96" for table length being specified. Pricing is standard for all table lengths.

FLUSH LID	PART NUMBER	CONFIGURATION	FINISH	LIST PRICE
	VIF-4-1-D-B-__K	2 Power and 2 RJ45 Cat 6 Data, Flush Lid	Black	\$492.50
	VIF-4-1-D-B-__DK			\$942.50
	VIF-4-1-D-S-__K	2 Power and 2 RJ45 Cat 6 Data, Flush Lid	Silver	\$492.50
	VIF-4-1-D-S-__DK			\$942.50
	VIF-4-1-D-GW-__K	2 Power and 2 RJ45 Cat 6 Data, Flush Lid	Gloss White	\$492.50
	VIF-4-1-D-GW-__DK			\$942.50
	VIF-4-1-D-AL-__K	2 Power and 2 RJ45 Cat 6 Data, Flush Lid	Aluminum	\$565.00
	VIF-4-1-D-AL-__DK			\$1,085.00
	VIF-4-1-D-SS-__K	2 Power and 2 RJ45 Cat 6 Data, Flush Lid	Brushed Stainless Steel	\$565.00
	VIF-4-1-D-SS-__K			\$1,085.00

LIFT LID	PART NUMBER	CONFIGURATION	FINISH	LIST PRICE
	VIL-4-1-D-B-__K	2 Power and 2 RJ45 Cat 6 Data, Lift Lid	Black	\$492.50
	VIL-4-1-D-B-__DK			\$942.50
	VIL-4-1-D-S-__K	2 Power and 2 RJ45 Cat 6 Data, Lift Lid	Silver	\$492.50
	VIL-4-1-D-S-__DK			\$942.50
	VIL-4-1-D-GW-__K	2 Power and 2 RJ45 Cat 6 Data, Lift Lid	Gloss White	\$492.50
	VIL-4-1-D-GW-__DK			\$942.50

**PRODUCT INFORMATION:**

Product Dimensions: See Specification and Ordering Information

Minimum Table Thickness..... 1.00"

Table Cutout For Villa Grommet..... 3.00" x 5.25"

See page 38 for Starter Cable and Interconnecting Cable UL Listed & CSA Certified, or ETL and cETLus

Innovative Power + Data Solutions

10 Mountain View Drive • Shelton, CT 06484 • P:800.521.3175 • F:203.924.6687 • www.electri-cable.com



# DAISYLINK™ SYSTEM – VILLA™ USB SERIES

**Power, USB, and Data Ready– Quick Kits— Single & Double**  
Simple and Clean DaisyChain Solution.

Single Kit Includes:

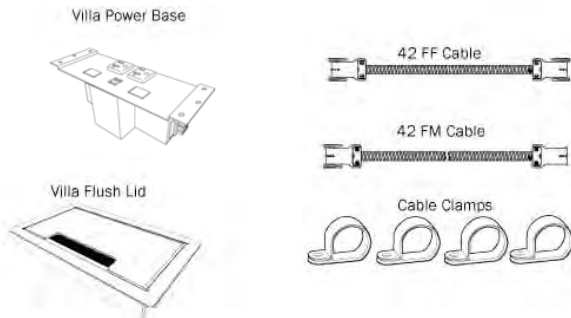

Replace \_\_\_\_ in Single Kit Part Number (K) with 36", 42", 48", 60" or 72" for table length being specified. Pricing is standard for all table lengths.

Change the "1" to a "2" to Specify Circuit 2.

Double Kit Includes:

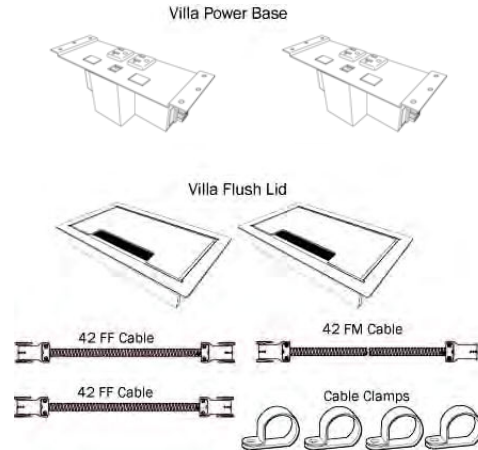

Replace \_\_\_\_ in Double Kit Part Number (DK) with 60", 72", 84", or 96" for table length being specified. Pricing is standard for all table lengths.

**Note:** Cable lengths are 1" longer than the table. Cables extend 1/2" off either side of the table for easy connection. Each Villa unit comes with mounting screws.

FLUSH LID	PART NUMBER	CONFIGURATION	FINISH	LIST PRICE
	VIF-41UDKOB-__K VIF-41UDKOB-__DK	2 Power, 2 USB 2.1 AMP charging ports, Flush Lid	Black	\$460.00 \$872.50
	VIF-41UDKOS-__K VIF-41UDKOS-__DK	2 Power, 2 USB 2.1 AMP charging ports, Flush Lid	Silver	\$460.00 \$872.50
	VIF-41UDKOGW-__K VIF-41UDKOGW-__DK	2 Power, 2 USB 2.1 AMP charging ports, Flush Lid	Gloss White	\$460.00 \$872.50
	VIF-41UKOAL__K VIF-41UKOAL__DK	2 Power, 2 USB 2.1 AMP charging ports, Flush Lid	Aluminum	\$530.00 \$1,015.00
	VIF-41UKOSS__K VIF-41UKOSS__DK	2 Power, 2 USB 2.1 AMP charging ports, Flush Lid	Brushed Stainless Steel	\$530.00 \$1,015.00

LIFT LID	PART NUMBER	CONFIGURATION	FINISH	LIST PRICE
	VIL-41UDKOB-__K VIL-41UDKOB-__DK	2 Power, 2 USB 2.1 AMP charging ports, Lift Lid	Black	\$460.00 \$872.50
	VIL-41UDKOS-__K VIL-41UDKOS-__DK	2 Power, 2 USB 2.1 AMP charging ports, Lift Lid	Silver	\$460.00 \$872.50
	VIL-41UDKOGW-__K VIL-41UDKOGW-__DK	2 Power, 2 USB 2.1 AMP charging ports, Lift Lid	Gloss White	\$460.00 \$872.50

**PRODUCT INFORMATION:**

Product Dimensions: See Specification and Ordering Information  
Minimum Table Thickness..... 1.00"  
Table Cutout For Villa Grommet..... 3.00" x 5.25"

See page 38 for Starter Cable and Interconnecting Cable UL Listed & CSA Certified, or ETL and cETLus

**Innovative Power + Data Solutions**

10 Mountain View Drive • Shelton, CT 06484 • P:800.521.3175 • F:203.924.6687 • www.electri-cable.com

# DAISYLINK™ SYSTEM — VILLA™ USB SERIES

## Power, USB, and Data – Quick Kits— Single & Double (Cont.)

Simple and Clean DaisyChain Solution.

### Single Kit Includes:

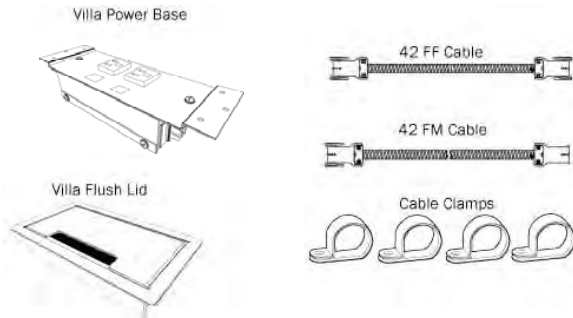

Replace \_\_\_\_ in Single Kit Part Number (K) with 36", 42", 48", 60" or 72" for table length being specified. Pricing is standard for all table lengths.

Change the "1" to a "2" to Specify Circuit 2.

### Double Kit Includes:

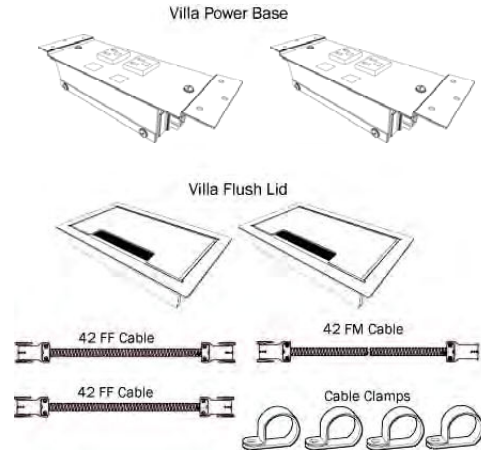

Replace \_\_\_\_ in Double Kit Part Number (DK) with 60", 72", 84", or 96" for table length being specified. Pricing is standard for all table lengths.

**Note:** Cable lengths are 1" longer than the table. Cables extend 1/2" off either side of the table for easy connection. Each Villa unit comes with mounting screws.

FLUSH LID	PART NUMBER	CONFIGURATION	FINISH	LIST PRICE
	VIF-41-UDB-__K VIF-41-UDB-__DK	2 Power, 2 USB 2.1 AMP ports, 2 RJ45 cat 6 data, Flush Lid	Black	\$575.00 \$1,102.50
	VIF-41-UDS-__K VIF-41-UDS-__DK	2 Power, 2 USB 2.1 AMP ports, 2 RJ45 cat 6 data, Flush Lid	Silver	\$575.00 \$1,102.50
	VIF-41-UDGW-__K VIF-41-UDGW-__DK	2 Power, 2 USB 2.1 AMP ports, 2 RJ45 cat 6 data, Flush Lid	Gloss White	\$575.00 \$1,102.50
	VIF-41-UDAL-__K VIF-41-UDAL-__DK	2 Power, 2 USB 2.1 AMP ports, 2 RJ45 cat 6 data, Flush Lid	Aluminum	\$645.00 \$1,245.00
	VIF-41-UDSS-__K VIF-41-UDSS-__DK	2 Power, 2 USB 2.1 AMP ports, 2 RJ45 cat 6 data, Flush Lid	Brushed Stainless Steel	\$645.00 \$1,245.00

LIFT LID	PART NUMBER	CONFIGURATION	FINISH	LIST PRICE
	VIL-41-UDB-__K VIL-41-UDB-__DK	2 Power, 2 USB 2.1 AMP ports, 2 RJ45 cat 6 data, Lift Lid	Black	\$575.00 \$1,102.50
	VIL-41-UDS-__K VIL-41-UDS-__DK	2 Power, 2 USB 2.1 AMP ports, 2 RJ45 cat 6 data, Lift Lid	Silver	\$575.00 \$1,102.50
	VIL-41-UDGW-__K VIL-41-UDGW-__DK	2 Power, 2 USB 2.1 AMP ports, 2 RJ45 cat 6 data, Lift Lid	Gloss White	\$575.00 \$1,102.50

### PRODUCT INFORMATION:

Product Dimensions: See Specification and Ordering Information  
 Minimum Table Thickness..... 1.00"  
 Table Cutout For Villa Grommet..... 3.00" x 5.25"

See page 38 for Starter Cable and Interconnecting Cable UL Listed & CSA Certified, or ETL and cETLus Certified

Innovative Power + Data Solutions

10 Mountain View Drive • Shelton, CT 06484 • P:800.521.3175 • F:203.924.6687 • www.electri-cable.com



# DAISYLINK™ SYSTEM — VILLA™ II SERIES

## Power and Data Ready– Quick Kits– Single & Double

Simple and Clean Daisy-Chain Solution.

**Single Kit Includes:**

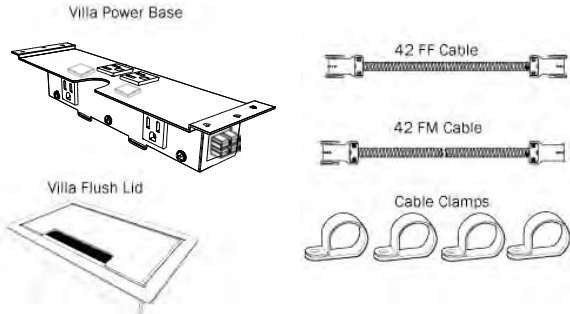

Replace \_\_\_\_ in Single Kit Part Number (K) with 36”, 42”, 48”, 60” or 72” for table length being specified. Pricing is standard for all table lengths.

Change the “1” to a “2” to Specify Circuit 2.

**Double Kit Includes:**

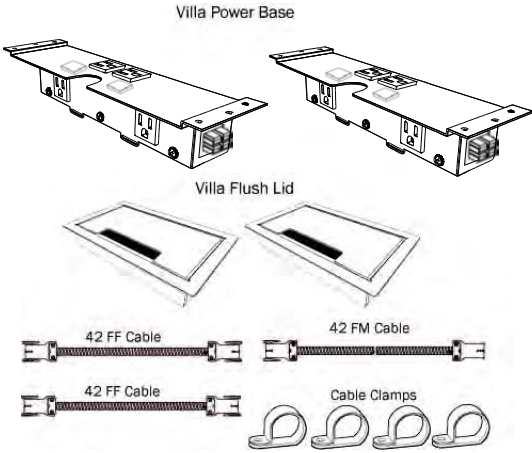

Replace \_\_\_\_ in Double Kit Part Number (DK) with 60”, 72”, 84”, or 96” for table length being specified. Pricing is standard for all table lengths.

**Note:** Cable lengths are 1” longer than the table. Cables extend 1/2” off either side of the table for easy connection. Each Villa unit comes with mounting screws.

FLUSH LID	PART NUMBER	CONFIGURATION	FINISH	LIST PRICE
	VIF2-41-DKOB__K VIF2-41-DKOB__DK	4 Power and Knockouts for 2 RJ45 Cat 6 Data, Flush Lid	Black	\$452.50 \$855.00
	VIF2-41-DKOS__K VIF2-41-DKOS__DK	4 Power and Knockouts for 2 RJ45 Cat 6 Data, Flush Lid	Silver	\$452.50 \$855.00
	VIF2-41DKOAL__K VIF2-41DKOAL__DK	4 Power and Knockouts for 2 RJ45 Cat 6 Data, Flush Lid	Aluminum	\$522.50 \$997.50
	VIF2-41DKOSS__K VIF2-41DKOSS__DK	4 Power and Knockouts for 2 RJ45 Cat 6 Data, Flush Lid	Brushed Stainless Steel	\$522.50 \$997.50

LIFT LID	PART NUMBER	CONFIGURATION	FINISH	LIST PRICE
	VIL2-41-DKOB__K VIL2-41-DKOB__DK	4 Power and Knockouts for 2 RJ45 Cat 6 Data, Lift Lid	Black	\$452.50 \$855.00
	VIL2-41-DKOS__K VIL2-41-DKOS__DK	4 Power and Knockouts for 2 RJ45 Cat 6 Data, Lift Lid	Silver	\$452.50 \$855.00

See page 38 for Starter Cable and Interconnecting Cable UL Listed & CSA Certified, or ETL and cETLus Certified

**PRODUCT INFORMATION:**

Product Dimensions: See Specification and Ordering Information  
 Minimum Table Thickness..... 1.00”  
 Table Cutout For Villa Grommet..... 3.00” x 5.25”

Innovative Power + Data Solutions

10 Mountain View Drive • Shelton, CT 06484 • P:800.521.3175 • F:203.924.6687 • www.electri-cable.com

# DAISYLINK™ SYSTEM — VILLA™ II SERIES

## Power and Data- Quick Kits— Single & Double (Cont.)

Simple and Clean Daisy-Chain Solution.

### Single Kit Includes:

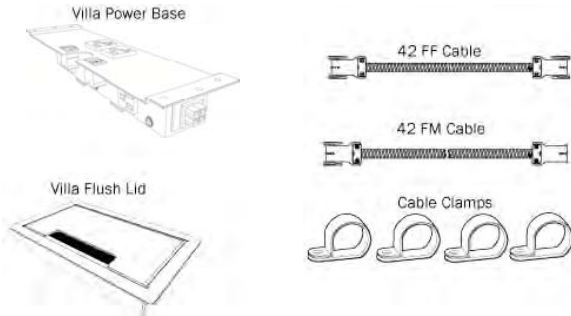

Replace \_\_\_\_ in Single Kit Part Number (K) with 36", 42", 48", 60" or 72" for table length being specified. Pricing is standard for all table lengths.

Change the "1" to a "2" to Specify Circuit 2.

### Double Kit Includes:

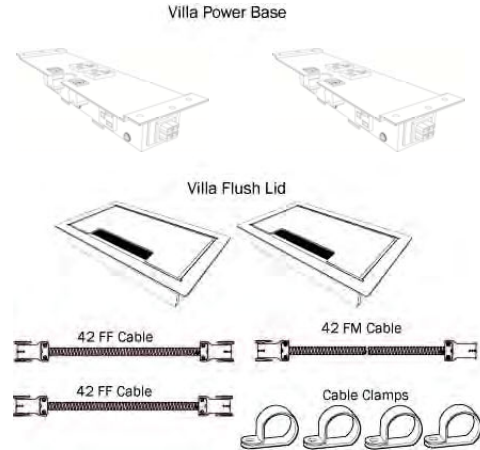

Replace \_\_\_\_ in Double Kit Part Number (DK) with 60", 72", 84", or 96" for table length being specified. Pricing is standard for all table lengths.

**Note:** Cable lengths are 1" longer than the table. Cables extend 1/2" off either side of the table for easy connection. Each Villa unit comes with mounting screws.

FLUSH LID	PART NUMBER	CONFIGURATION	FINISH	LIST PRICE
	VIF2-41-D-B-__K VIF2-41-D-B-__DK	4 Power and 2 RJ45 Cat 6 Data, Flush Lid	Black	\$567.50 \$1,085.00
	VIF2-41-D-S-__K VIF2-41-D-S-__DK	4 Power and 2 RJ45 Cat 6 Data, Flush Lid	Silver	\$567.50 \$1,085.00
	VIF2-41-D-AL-__K VIF2-41-D-AL-__DK	4 Power and 2 RJ45 Cat 6 Data, Flush Lid	Aluminum	\$637.50 \$1,227.50
	VIF2-41-DSS-__K VIF2-41-DSS-__DK	4 Power and 2 RJ45 Cat 6 Data, Flush Lid	Brushed Stainless Steel	\$637.50 \$1,227.50

LIFT LID	PART NUMBER	CONFIGURATION	FINISH	LIST PRICE
	VIL2-41-D-B-__K VIL2-41-D-B-__DK	4 Power and 2 RJ45 Cat 6 Data, Lift Lid	Black	\$567.50 \$1,085.00
	VIL2-41-D-S-__K VIL2-41-D-S-__DK	4 Power and 2 RJ45 Cat 6 Data, Lift Lid	Silver	\$567.50 \$1,085.00

See page 38 for Starter Cable and Interconnecting Cable UL Listed & CSA Certified, or ETL and cETLus Certified

**PRODUCT INFORMATION:**

Product Dimensions: See Specification and Ordering Information

Minimum Table Thickness..... 1.00"

Table Cutout For Villa Grommet..... 3.00" x 5.25"

Innovative Power + Data Solutions

10 Mountain View Drive • Shelton, CT 06484 • P:800.521.3175 • F:203.924.6687 • www.electri-cable.com

# DAISYLINK™ SYSTEM — VILLA™ II USB SERIES

Power, USB, and Data Ready- Quick Kits— Single & Double

Simple and Clean DaisyChain Solution.

Single Kit Includes:

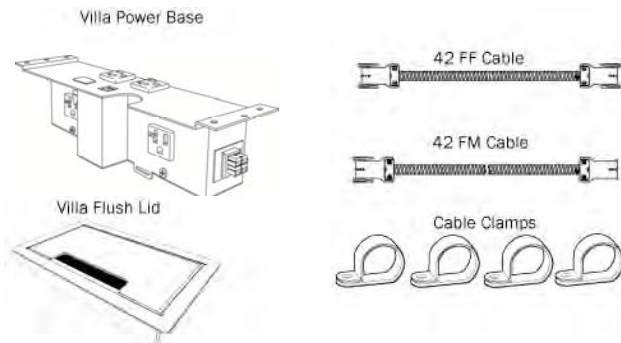

Replace \_\_\_\_ in Single Kit Part Number (K) with 36", 42", 48", 60" or 72" for table length being specified. Pricing is standard for all table lengths.

Double Kit Includes:

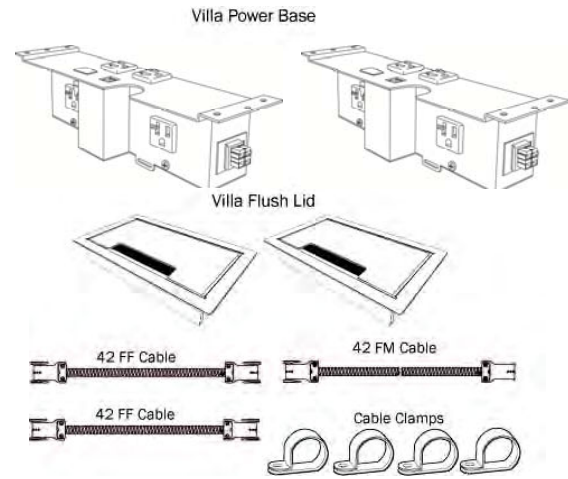

Replace \_\_\_\_ in Double Kit Part Number (DK) with 60", 72", 84", or 96" for table length being

**Note:** Cable lengths are 1" longer than the table. Cables extend 1/2" off either side of the table for easy connection.

FLUSH LID	PART NUMBER	CONFIGURATION	FINISH	LIST PRICE
	VIF2U-41DKOB__K VIF2U41DKOB__DK	4 Power, 2 USB 2.1 AMP charging ports, Knockout for 1 RJ45 Cat 6 Data, Flush Lid	Black	\$532.50 \$1,017.50
	VIF2U-41DKOS__K VIF2U41DKOS__DK	4 Power, 2 USB 2.1 AMP charging ports, Knockout for 1 RJ45 Cat 6 Data, Flush Lid	Silver	\$532.50 \$1,017.50
	VIF2U41DKOGW__K VIF2U41DKGW__DK	4 Power, 2 USB 2.1 AMP charging ports, Knockout for 1 RJ45 Cat 6 Data, Flush Lid	Gloss White	\$532.50 \$1,017.50
	VIF2U-41KOAL__K VIF2U41KOAL__DK	4 Power, 2 USB 2.1 AMP charging ports, Knockout for 1 RJ45 Cat 6 Data, Flush Lid	Aluminum	\$602.50 \$1,160.00
	VIF2U-41KOSS__K VIF2U41KOSS__DK	4 Power, 2 USB 2.1 AMP charging ports, Knockout for 1 RJ45 Cat 6 Data, Flush Lid	Brushed Stainless Steel	\$602.50 \$1,160.00

LIFT LID	PART NUMBER	CONFIGURATION	FINISH	LIST PRICE
	VIL2U-41DKOB__K VIL2U41DKOB__DK	4 Power, 2 USB 2.1 AMP charging ports, Knockout for 1 RJ45 Cat 6 Data, Lift Lid	Black	\$532.50 \$1,017.50
	VIL2U-41DKOS__K VIL2U41DKOS__DK	4 Power, 2 USB 2.1 AMP charging ports, Knockout for 1 RJ45 Cat 6 Data, Lift Lid	Silver	\$532.50 \$1,017.50
	VIL2U41DKOGW__K VIL2U41DKGW__DK	4 Power, 2 USB 2.1 AMP charging ports, Knockout for 1 RJ45 Cat 6 Data, Lift Lid	Gloss White	\$532.00 \$1,017.50

**PRODUCT INFORMATION:**

Product Dimensions: See Specification and Ordering Information  
 Minimum Table Thickness..... 1.00"  
 Table Cutout For Villa Grommet..... 3.00" x 5.25"

See page 38 for Starter Cable and Interconnecting Cable UL Listed & CSA Certified, or ETL and cETLus Certified

Innovative Power + Data Solutions

10 Mountain View Drive • Shelton, CT 06484 • P:800.521.3175 • F:203.924.6687 • www.electri-cable.com

# DAISYLINK™ SYSTEM — VILLA™ II USB SERIES

## Power, USB, and Data– Quick Kits— Single & Double (Cont.)

Simple and Clean DaisyChain Solution.

### Single Kit Includes:

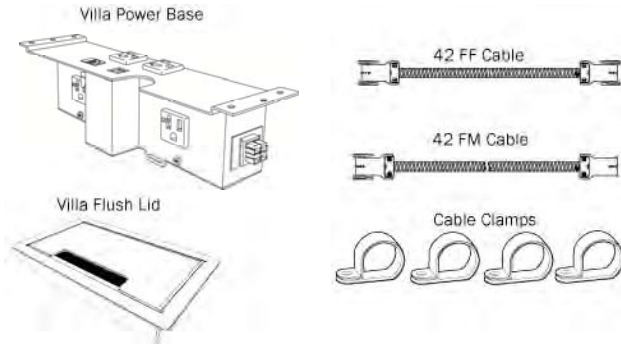

Replace \_\_\_\_ in Single Kit Part Number (K) with 36", 42", 48", 60" or 72" for table length being specified. Pricing is standard for all table lengths.

### Double Kit Includes:

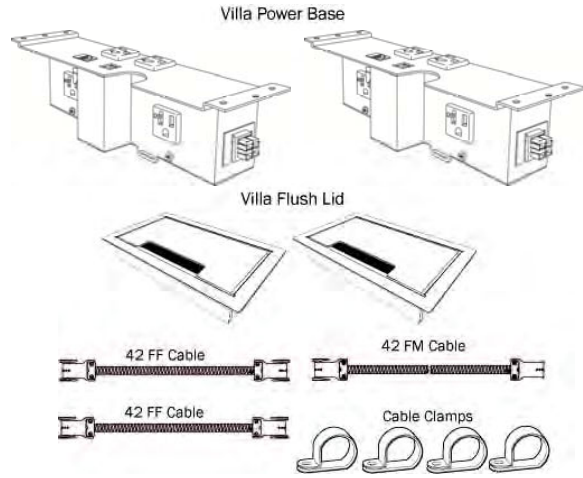

Replace \_\_\_\_ in Double Kit Part Number (DK) with 60", 72", 84", or 96" for table length being

**Note:** Cable lengths are 1" longer than the table. Cables extend 1/2" off either side of the table for easy connection.

FLUSH LID	PART NUMBER	CONFIGURATION	FINISH	LIST PRICE
	VIF2U-41-D-B__K VIF2U-41-DB__DK	4 Power, 2 USB 2.1 AMP ports, 1 RJ45 cat 6 data, Flush Lid	Black	\$590.00 \$1,132.50
	VIF2U-41-D-S__K VIF2U-41-DS__DK	4 Power, 2 USB 2.1 AMP ports, 1 RJ45 cat 6 data, Flush Lid	Silver	\$590.00 \$1,132.50
	VIF2U-41-DG__K VIF2U-41DG__DK	4 Power, 2 USB 2.1 AMP ports, 1 RJ45 cat 6 data, Flush Lid	Gloss White	\$590.00 \$1,132.50
	VIF2U-41UDAL__K VIF2U41DAL__DK	4 Power, 2 USB 2.1 AMP ports, 1 RJ45 cat 6 data, Flush Lid	Aluminum	\$660.00 \$1,275.00
	VIF2U-41UDSS__K VIF2U41DSS__DK	4 Power, 2 USB 2.1 AMP ports, 1 RJ45 cat 6 data, Flush Lid	Brushed Stainless Steel	\$660.00 \$1,275.00

LIFT LID	PART NUMBER	CONFIGURATION	FINISH	LIST PRICE
	VIL2U-41-D-B__K VIL2U-41-DB__DK	4 Power, 2 USB 2.1 AMP ports, 1 RJ45 cat 6 data, Lift Lid	Black	\$590.00 \$1,017.50
	VIL2U-41-D-S__K VIL2U-41-DS__DK	4 Power, 2 USB 2.1 AMP ports, 1 RJ45 cat 6 data, Lift Lid	Silver	\$590.00 \$1,017.50
	VIL2U-41-DG__K VIL2U-41DG__DK	4 Power, 2 USB 2.1 AMP ports, 1 RJ45 cat 6 data, Lift Lid	Gloss White	\$590.00 \$1,017.50

### PRODUCT INFORMATION:

Product Dimensions: See Specification and Ordering Information

Minimum Table Thickness..... 1.00"

Table Cutout For Villa Grommet..... 3.00" x 5.25"

See page 38 for Starter Cable and Interconnecting Cable UL Listed & CSA Certified, or ETL and cETLus Certified

Innovative Power + Data Solutions

10 Mountain View Drive • Shelton, CT 06484 • P:800.521.3175 • F:203.924.6687 • www.electri-cable.com



# DAISYLINK™ SYSTEM – VILLA™ & VILLA™ II SERIES

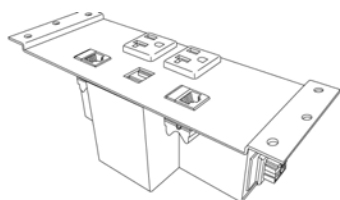

## Build Your Own Options– Power Bases

Simple and Clean Daisy-Chain Solution.

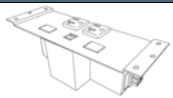
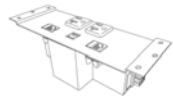

See page 38 for Starter Cable and Interconnecting Cable Options.

See page 119 for Villa Grommets.

VILLA POWER BASES	PART NUMBER	CONFIGURATION	FINISH	LIST PRICE
	VIL-4-1-U-DKO-B VIL-4-1-U-DKO-S VIL-4-1-U-DKO-GW	2 Power, 2 USB 2.1 AMP charging ports, 2 RJ45 Cat 6 Data Knockouts	Black Silver Gloss White	\$245.00
	VIL-4-1-U-D-B VIL-4-1-U-D-S VIL-4-1-U-D-GW	2 Power, 2 USB 2.1 AMP charging ports, 2 RJ45 cat6 Data	Black Silver Gloss White	\$362.50
	VIL-4-1-DKO-B VIL-4-1-DKO-S VIL-4-1-DKO-GW	2 Power and Knockouts for 2 RJ45 Cat 6 Data	Black Silver Gloss White	\$165.00
	VIL-4-1-D-B VIL-4-1-D-S VIL-4-1-D-GW	2 Power and 2 RJ45 Cat 6 Data	Black Silver Gloss White	\$282.50

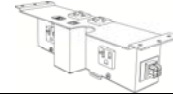
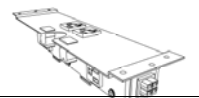
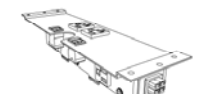
VILLA II POWER BASES	PART NUMBER	CONFIGURATION	FINISH	LIST PRICE
	VIL2-4-1-U-DKO-B VIL2-4-1-U-DKO-S VIL2-4-1-U-DKO-W	4 Power, 2 power on top with 2 USB 2.1 AMP charging ports, Knockouts for 1 RJ45 Cat 6 Data, and 2 power below	Black Silver Gloss White	\$317.50
	VIL2-4-1-U-D-B VIL2-4-1-U-D-S VIL2-4-1-U-D-W	4 Power, 2 power on top with 2 USB 2.1 AMP charging ports, 1 RJ45 Cat 6 Data, and 2 power below	Black Silver Gloss White	\$377.50
	VIL2-4-1-DKO-B VIL2-4-1-DKO-S VIL2-4-1-DKO-W	4 Power, 2 on Top and 2 Below, and Knockouts for 2 RJ45 Cat 6 Data	Black Silver Gloss White	\$237.50
	VIL2-4-1-D-B VIL2-4-1-D-S VIL2-4-1-D-W	4 Power, 2 on Top and 2 Below, and 2 RJ45 Cat 6 Data	Black Silver Gloss White	\$355.00

Change the “1” to a “2” to Specify Circuit 2.

UL Listed & CSA Certified, or ETL and cETLus Certified

**PRODUCT INFORMATION:**

Product Dimensions: See Specification and Ordering Information

Minimum Table Thickness..... 1.00”

Table Cutout For Villa Grommet..... 3.00” x 5.25”

Innovative Power + Data Solutions







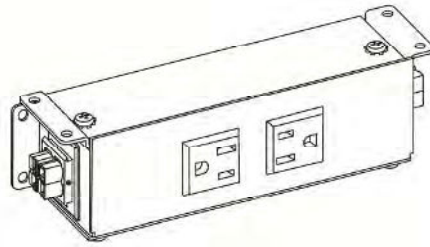

10 Mountain View Drive • Shelton, CT 06484 • P:800.521.3175 • F:203.924.6687 • www.electri-cable.com

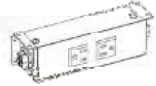
# DAISYLINK SYSTEM—VILLA UM

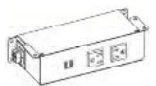
DaisyLink Under Mount Solution

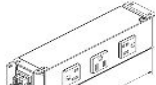

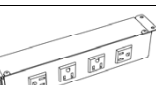
Change the “1” to a “2” to Specify Circuit 2.  
Data sold Separately.

VILLA UM DAISYLINK				
	PART NUMBER	DESCRIPTION	FINISH	LIST PRICE
	VIL-UM-41-2-B VIL-UM-41-2-S	Villa Under Mount, 2 Power	Black Silver Pearl	\$182.50
	VIL-UM-41-2DKOB VIL-UM-41-2DKOS	Villa Under Mount, 2 Power, Knockouts for 2 Data	Black Silver Pearl	\$195.00
	VIL-UM-41-2U-B VIL-UM-41-2U-S	Villa Under Mount, 2 Power, 2 2.1 amp USB	Black Silver Pearl	\$262.50
	VIL-UM-41-2UDKOB VIL-UM-41-2UDKOS	Villa Under Mount, 2 Power, 2 2.1amp USB, Knockouts for 2 Data	Black Silver Pearl	\$275.00
	VIL-UM-41-3-B VIL-UM-41-3-S	Villa Under Mount, 3 Power	Black Silver Pearl	\$193.75
	VIL-UM-41-3DKOB VIL-UM-41-3DKOS	Villa Under Mount, 3 Power, Knockouts for 2 Data	Black Silver Pearl	\$206.25
	VIL-UM-41-4-B VIL-UM-41-4-S	Villa Under Mount, 4 Power	Black Silver Pearl	\$210.00
	VIL-UM-41-4DKOB VIL-UM-41-4DKOS	Villa Under Mount, 4 Power, Knockouts for 2 Data	Black Silver Pearl	\$222.50
	VIL-UM-41-U-B VIL-UM-41-U-S	Villa Under Mount, 2 2.1 amp USB	Black Silver Pearl	\$287.50

**TABLE REQUIREMENTS:**

Product Dimensions.....See Specification and Ordering Information  
 Minimum Table Thickness.....1.00”  
 Table Cutout.....Mounts Beneath The Table Surface

ETL Listed

Innovative Power + Data Solutions



10 Mountain View Drive • Shelton, CT 06484 • P:800.521.3175 • F:203.924.6687 • www.electri-cable.com



# VILLA UM – HAT KITS

Power that moves with you.

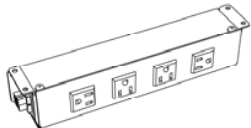
## HAT Kits: Step 1- Select Your Power Unit

DaisyLink® Quick Kits Require The Following Selection:

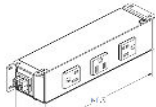
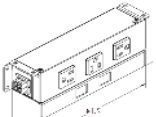
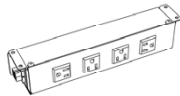
<p><b>Step 1: Power Unit</b></p> 	<p><b>Step 2: Cable Kit</b></p> 	<p><b>Step 3: Power Infeed</b></p> 
--	--	--

VILLA UM DAISYLINK FOR HAT KITS				
	PART NUMBER	DESCRIPTION	FINISH	LIST PRICE
	VIL-UM-41-3-B VIL-UM-41-3-S	Villa Under Mount, 3 Power	Black Silver Pearl	\$193.75
	VIL-UM-41-3DKOB VIL-UM-41-3DKOS	Villa Under Mount, 3 Power, Knockouts for 2 Data	Black Silver Pearl	\$206.25
	VIL-UM-41-4-B VIL-UM-41-4-S	Villa Under Mount, 4 Power	Black Silver Pearl	\$210.00
	VIL-UM-41-4DKOB VIL-UM-41-4DKOS	Villa Under Mount, 4 Power, Knockouts for 2 Data	Black Silver Pearl	\$222.50

ETL Certified

**TABLE REQUIREMENTS:**

Product Dimensions.....See Specification and Ordering Information

Minimum Table Thickness.....1.00”

Table Cutout.....Mounts Beneath The Table Surface

Note: HAT Kits require Power Unit, Cable Kit, and Power Infeed all ordered separately



# DAISYLINK SYSTEM – VILLA™ UM

## Power, USB, and Data – Quick Kits—Single & Double

Simple and Clean DaisyChain Solution.

### Single Kit Includes:

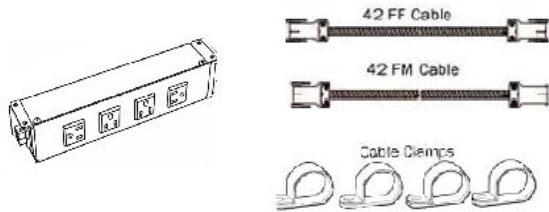

Replace \_\_\_\_ in Single Kit Part Number (K) with 36", 42", 48", 60", 66", 72", 84" or 96" for table length being specified. Pricing is standard for all table lengths.

### Double Kit Includes:

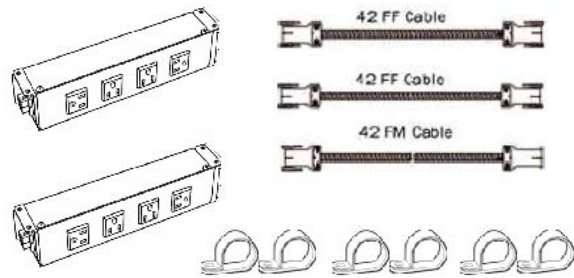

Replace \_\_\_\_ in Double Kit Part Number (DK) with 60", 66", 72", 84", or 96" for table length being specified. Pricing is standard for all table lengths.

**Note: Change the -41 to -42 to Specify Circuit 2.  
Replace "B" in Part Number for Silver Pearl Finish.**

	PART NUMBER	DESCRIPTION	FINISH	LIST PRICE
	VUM-41-2-B-__K VUM-41-2-B-__DK	Villa Under Mount, 2 Power	Black	\$302.50 \$562.50
	VUM-41-2DKOB__K VUM-412DKOB__DK	Villa Under Mount, 2 Power, Knockouts for 2 Data	Black	\$315.00 \$587.50
	VUM-41-2U-B-__K VUM-41-2U-B-__DK	Villa Under Mount, 2 Power, 2 2.1 amp USB	Black	\$385.50 \$722.50
	VUM-412UDKOB__K VUM412UDKOB__DK	Villa Under Mount, 2 Power, 2 2.1amp USB, Knockouts for 2 Data	Black	\$395.00 \$747.50
	VUM-41-3-B-__K VUM-41-3-B-__DK	Villa Under Mount, 3 Power	Black	\$313.75 \$585.00
	VUM-41-3DKOB__K VUM-413DKOB__DK	Villa Under Mount, 3 Power, Knockouts for 2 Data	Black	\$326.25 \$610.00
	VUM-41-4-B-__K VUM-41-4-B-__DK	Villa Under Mount, 4 Power	Black	\$330.00 \$617.50
	VUM-41-4DKOB-__K VUM-414DKOB-__DK	Villa Under Mount, 4 Power, Knockouts for 2 Data	Black	\$342.50 \$642.50



Innovative Power + Data Solutions

10 Mountain View Drive • Shelton, CT 06484 • P:800.521.3175 • F:203.924.6687 • www.electri-cable.com

# VILLA UM – HAT KITS

Power that moves with you.

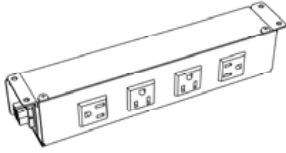
## HAT Kits: Steps 2 & 3- Select Your Cable Kit & Power Infeed



DaisyLink® Quick Kits Require The Following Selection:		
<b>Step 1: Power Unit</b> 	<b>Step 2: Cable Kit</b> 	<b>Step 3: Power Infeed</b> 

Power Slip Cable Kits are based on table length and include:  
 2 DaisyLink® Male Cables  
 2 Mounting Brackets & Mounting Screws  
 2 Clamps  
 1 Loop Cable

### Step 2: Select Your Cable Kit

CABLE KITS	PART NUMBER	DESCRIPTION	LIST PRICE
	HAT42-CAB-42K	42" Table Kit: 2 42FM 12" Cables, 2 Mounting Brackets, Mounting Screws, 2 Clamps, 48" Loop Cable with Black Mesh	\$357.50
	HAT42-CAB-48K	48" Table Kit: 2 42FM 13" Cables, 2 Mounting Brackets, Mounting Screws, 2 Clamps, 48" Loop Cable with Black Mesh	
	HAT42-CAB-54K	54" Table Kit: 2 42FM 16" Cables, 2 Mounting Brackets, Mounting Screws, 2 Clamps, 48" Loop Cable with Black Mesh	
	HAT42-CAB-60K	60" Table Kit: 2 42FM 19" Cables, 2 Mounting Brackets, Mounting Screws, 2 Clamps, 48" Loop Cable with Black Mesh	
	HAT42-CAB-66K	66" Table Kit: 2 42FM 22" Cables, 2 Mounting Brackets, Mounting Screws, 2 Clamps, 48" Loop Cable with Black Mesh	
	HAT42-CAB-72K	72" Table Kit: 2 42FM 25" Cables, 2 Mounting Brackets, Mounting Screws, 2 Clamps, 48" Loop Cable with Black Mesh	
	HAT42-CAB-84K	84" Table Kit: 2 42FM 31" Cables, 2 Mounting Brackets, Mounting Screws, 2 Clamps, 48" Loop Cable with Black Mesh	

### Step 3: Select Your Starter Infeed

POWER INFEED OPTIONS	PART NUMBER	DESCRIPTION	LIST PRICE
	42SB2- LENGTH- B	Multi-Circuit Hardwire Power Infeed with black mesh	\$57.50 + \$.150 per inch
	42 QD INSERT	Insert for Floor Box and Wall Outlet Applications. Fits Standard Decora® Opening.	\$115.00
	4220AP1-72-B	Single Circuit 20 Amp Power Infeed with 72" Molded Plug with Black Mesh	\$227.50

**PRODUCT INFORMATION:**

Note HAT Kits require Power Unit, Cable Kit, and Power Infeed all ordered separately

ETL Certified

Innovative Power + Data Solutions

10 Mountain View Drive • Shelton, CT 06484 • P:800.521.3175 • F:203.924.6687 • www.electri-cable.com

# VILLA & VILLA II SERIES GROMMETS

Stylish Accessories.

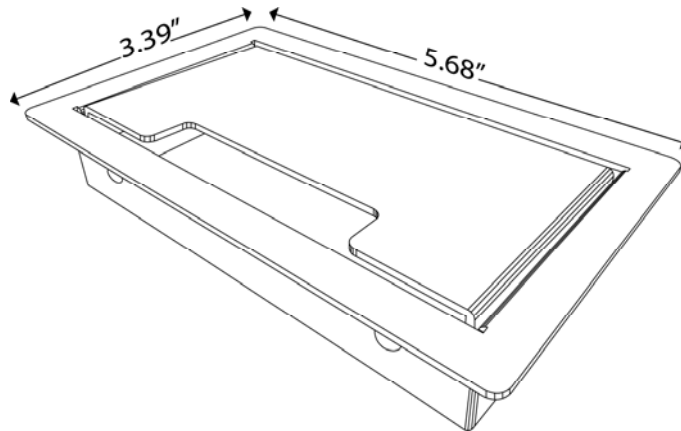

(Flush Grommet Shown, dimensions are the same for all Villa Grommets)

FLUSH LID	PART NUMBER	FINISH	LIST PRICE
	VIL-GROM-F-AL	Brushed Aluminum	\$170.00
	VIL-GROM-F-SS	Brushed Stainless Steel	\$170.00
	VIL-GROM-F-S	Silver	\$95.00
	VIL-GROM-F-B	Black	\$95.00
	VIL-GROM-F-W	Gloss White	\$95.00

LIFT LID	PART NUMBER	FINISH	LIST PRICE
	VIL-GROM-L-S	Silver	\$95.00
	VIL-GROM-L-B	Black	\$95.00
	VIL-GROM-L-W	Gloss White	\$95.00

ETL Listed

**TABLE REQUIREMENTS:**

Table Cutout.....3" x 5.25"

# WIRE MANAGERS

Horizontal & Vertical Cord Management Solutions.

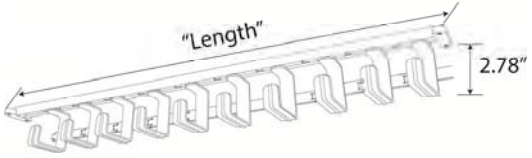
CABLE COMBER	PART NUMBER	QUANTITY	SIZE	LIST PRICE
	CABLE COMBER	1	24"	\$82.50

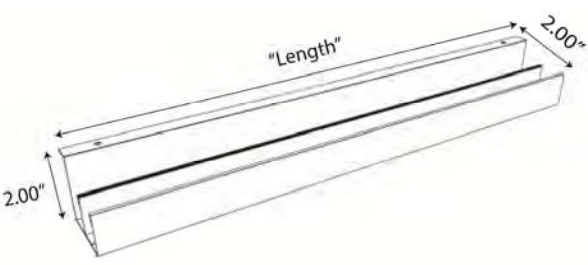
CABLE CANAL	PART NUMBER	QUANTITY	SIZE	LIST PRICE
	CABLE CANAL-18"	1	18"	\$105.00
	CABLE CANAL-24"	1	24"	\$115.00
	CABLE CANAL-30"	1	30"	\$140.00
	CABLE CANAL-36"	1	36"	\$150.00
	CABLE CANAL-42"	1	42"	\$200.00

\*Provides Separate Channel for Power and Data Cables.

CABLE CHANNEL	PART NUMBER	QUANTITY	FINISH	LIST PRICE
	CABLE CHANNEL	10	BLACK	\$210.00

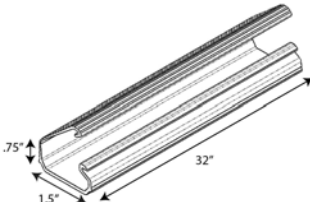
CABLE LATCH*	PART NUMBER	QUANTITY	FINISH	LIST PRICE
	CABLE LATCH	10	BLACK	\$182.50

\* Snaps closed for securing cables

**PRODUCT INFORMATION:**

Mounts to Underside of a Work surface

Innovative Power + Data Solutions

10 Mountain View Drive • Shelton, CT 06484 • P:800.521.3175 • F:203.924.6687 • [www.electri-cable.com](http://www.electri-cable.com)

# WIRE MANAGERS (CONT.)

Horizontal & Vertical Cord Management Solutions.

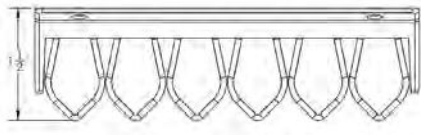
CABLE GRIP	PART NUMBER	QUANTITY	FINISH	LIST PRICE
	GRIP6-B	25	BLACK	\$262.50
	GRIP6-AL	25	SILVER	\$262.50

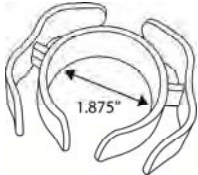
CABLE CLIP	PART NUMBER	QUANTITY	FINISH	LIST PRICE
	CABLE CLIP	25	SILVER	\$227.50

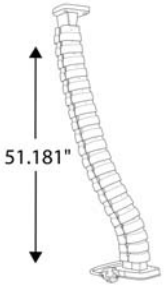
SNAKE	PART NUMBER	QUANTITY	SIZE	FINISH	LIST PRICE
	SNAKE-BL SNAKE-S SNAKE-W	1	51.181"	BLACK SILVER WHITE	\$100.00

SLINKY	PART NUMBER	QUANTITY	SIZE	FINISH	LIST PRICE
	SLINKY-BL SLINKY-S SLINKY-W	1	Floor to Under Worksurface	BLACK SILVER WHITE	\$92.50

**PRODUCT INFORMATION:**

Mounts to Underside of a Work surface or can be used to manage cords from the underside of the work surface to the floor.

## Guarantee

ECA stands behind the quality of all the products we manufacture. If at any time you are not fully satisfied with your purchase please contact us. We will work with you to resolve the concern and if we cannot satisfy you we will provide you with a credit or refund. Custom product configurations and telecom plates are excluded.

## Return Policy

We accept back Quick Ship items shipped within 30 days (excluding custom-made items and telecom plates) in new condition with a 25% restocking fee. Contact our customer service department before shipping items back for a Return Authorization Number. Products being returned must be packed well and securely to arrive back here in undamaged, resalable condition within 60 days of RMA being issued. When possible, please insert a copy of your original invoice or packing slip inside the box. Please be sure to include all original accessories to assure proper credit.

## Privacy Policy

ECA knows that you care how information about you is used and shared and we are committed to protecting your privacy. We do not rent or sell any of your customer's information to third parties. All information is held in strict confidence. The following details our Privacy Policy. We reserve the right at any time to modify or update our policy. By visiting our website, you are accepting the practices described in this Privacy Notice.

## Shipping and Delivery

ECA's lead time varies by product. While many of our products are offered on Quick Ship and will ship within 48 hours, there are others that can take longer. Lead time will be noted by product on the site. Customer service will contact you if your order requires more time to process. We ship via UPS – unless you specify another carrier or the order is large and can be shipped more economically via truck. Our preferred

Freight charges are based on the weight of your order, shipping zone in the continental US and an added handling fee. Additional charges may apply to items that require special packaging, are oversized or heavyweight, or require special handling by the carrier. Large items or quantity orders may ship by truck. Freight charges will be prepaid and added to your invoice. Or, contact us if you would like to charge freight to your own account.

Customers who request address changes, after shipment, will incur a flat re-routing fee of \$25.00 plus any additional transportation fee charged by the shipping carrier. If the customer requests the package to be returned to ECA, the 25% restocking fee will apply.

## Expediting Orders

ECA reserves the right to charge for services incurred to expedite orders through our production process. The following expedite fees may apply:

- Orders less than \$500.00 are subject to a onetime flat fee of \$50.00
- Orders \$500.00 - \$1,500.00 are subject to a onetime flat fee \$100.00
- Orders \$1,500 and up are subject to a onetime flat fee of \$195.00

## Minimum Order

There is a minimum order value of \$25.00 per order required. If the product selected does not meet this minimum it will be billed at the \$25.00 value.

## Resale Orders

All shipments to CA, CO, CT, FL, GA, IL, KS, MA, MD, MI, MN, NJ, NY, OH, TX, and WA addresses are subject to state sales tax. Clients holding valid Resale Certificates, and who are purchasing with the intent of reselling our products, are tax exempt. If your resale certificate is on file with us, just click the link during checkout that indicates your status, and tax will be removed from your order upon verification.

## Price Quotations and Custom Orders

Items custom-made to your exact specifications require a 50% deposit upon order placement and are not returnable. Please contact us directly to discuss custom items and obtain a pricing proposal.

## Blanket Orders

We provide opportunities for quantity discounts based on blanket purchase orders which can be arranged with shipments occurring over a 6-12 month period. Please call to arrange pricing and terms.

## Prices

Pricing is effective February 1, 2018 and subject to change without notice.

## Colors

Although we do our best to provide color photographs that are representative of our finishes, some products and color swatches shown on this website may not exactly match the actual color of the product. If you need to confirm a color, please call and we will send a color sample for approval.

## Specification/Installation Drawings

The specification/installation drawings are provided to help give dimensions and installation guidelines for our products. If you need a dimension not shown, or more specific information, please contact our customer service department for help.

## Terms

We accept VISA, MasterCard, Discover and American Express. Net terms may be established, please request our credit application.

# DEKKO

**EC A**

10 Mountain View Drive, Shelton, CT 06484  
203.924.6617

[dekkopower.com](http://dekkopower.com)

**2021**

**REV - B**